



SCREW CAM CLAMP

(Double Eye Type)

SWC-N

Operation Manual

This operation manual explains the basic operation and handling of the clamps. Please read this manual carefully before use and observe the precautions for safe operation.

SUPER TOOL CO., LTD.

 brand lifting clamps are energy-saving lifting equipment which have been developed for the purpose of transporting steel materials.

Proper use

Operate lifting clamps after carefully reading and understanding this instruction manual for enhancing efficiency and safety of operation.

Prime efficiency and economy

Advanced functions, reasonableness and versatile applications of finely and carefully designed  lifting clamps ensure prime efficiency and economy.

Special considerations on safety

We conduct a pulling test with a load three times (or twice) of rated capacity and a manufacturing serial number is marked on each product, thus directing a special attention to safety.

Precautions for safety operation

(Pages 1~10 are comon to all lifting clamp models)

Be sure to read this instruction manual carefully before use.

Mistaken use of lifting clamp may cause a danger such as dropping of load.

Education of "crane safety regulations," "operation manual for lifting clamp," "your company's operation standards," etc. should be given before actual operation not only to business owners who have purchased clamps but also to their operators to ensure that actual operators have acquired enough knowledge, safety information, and precautions of the clamps.

Safety precautions are divided into two classifications in this manual; "Warning" and "Caution,".



WARNING:

Indicates a potentially hazardous situation which, if not avoided, could result in death or serious injury.





CAUTION:

Indicates a potentially hazardous situation which, if not avoided, could result in medium damage or slight injury, or could result in property damage.

While only mentioned in  CAUTION, failure to comply with them still may lead to a serious disaster. As such, do not fail to pay attention both to WARNING and CAUTION which are of great importance.

Meanings of Signs

The signs of  and  indicate that precautions should be taken.

The contents of warning or caution are described at each sign.



The sign of  indicates prohibited actions.

The sign of  indicates that an action is enforced or instructed.







Two point lift for  righthand figure.

※ After reading this manual, make sure to keep it at a place of easy access by any users.







1. Handling in general

 WARNING	
<ul style="list-style-type: none"> ● Do not operate until the contents of the operation manual, and caution tag/plate are thoroughly read and understood. ● Do not operate without a legal qualification. ● Be sure to clear of the area of the operation for lifting or turning a load against possible drop off or fall over. ● Do not use for other than intended purpose. 	 Prohibited
<ul style="list-style-type: none"> ● Make sure to execute an inspection periodically and before each operation. 	 Instructed



2. Check before operation





 WARNING	
<ul style="list-style-type: none"> ● Do not use clamp unsuitable for the operation method. ● Do not use clamp of an abnormal condition; deformed, cracked, worn, malfunctioning, etc. ● If the load is under the following conditions, do not use clamp. (A material of fragile, high-hardness, low-hardness or extremely low-hardness, or a member with the gripping part tapered down more than 8°) 	 Prohibited
<ul style="list-style-type: none"> ● Check the type, rated capacity, clamp range, and “periodic inspection completed” label displayed on clamp body. ● The load to be lifted shall be within an allowable range of rated capacity of clamp. ● Thickness of load shall be within designated clamping range. 	 Instructed
 CAUTION	
<ul style="list-style-type: none"> ● Do not use clamp for the load under the following conditions. (Load to be lifted is more than 150°C, or in an atmosphere or solution of acid or alkaline chemicals less than minus 20°C) 	 Prohibited
<ul style="list-style-type: none"> ● Sling to be used for the clamp shall be an appropriate one for lifting operation. 	 Instructed

3. Lifting operation





 WARNING	
<ul style="list-style-type: none"> ● Do not use clamp, lifting at one point. (excluding special or custom ordered products) ● Do not use the clamp in the following ways of lifting: lifting of two or more individual objects at one time. (overlapped loads, padded load etc. , or side gripping) ● Do not use the clamp for pulling out steel plate sheet from the steel sheet pile or for vertical lifting of the sheet. ● Do not use the clamp when strong wind may threaten to cause any danger. ● Do not use the clamp for a hydraulic shovel. 	 Prohibited
<ul style="list-style-type: none"> ● Install two or more clamps in a balanced way to keep the balance of load. 	 Two point lift
<ul style="list-style-type: none"> ● The lifting angle of the clamps and the dividing angle should be kept within the allowable angles according to types. Load should be inserted to the innermost end of the jaw opening. ● When you use the clamp with a lock mechanism, never fail to have the lock engaged. 	 Instructed
 CAUTION	
<ul style="list-style-type: none"> ● If oil, paint, scale, rust, etc. are on the gripping pad, do not use the clamp. ● Do not drop clamp or drag on the ground. 	 Prohibited

4. Operation of a crane

 WARNING	
<ul style="list-style-type: none"> ● Never lift a load exceeding the rated capacity. ● Do not operate a crane in such a way as to give an impact to the load or the clamp. ● Do not allow a person to stand on the load or to carry him. ● Do not lift a load which is not free from any other objects. ● Do not release the lock of clamp while lifting load. ● Avoid unintended contact by load to an adjacent member or to the clamp, which has been removed from the load. 	 Prohibited

<ul style="list-style-type: none"> ● Stop the lifting operation by crane for a moment when the load is applied to the lifting ring for safety checking. (depth of the load into the clamp opening; status of locking). ● Stop the operation of the crane just before the load reaches the ground, and check the following matters: (Inclination or falling over of the load and security around the landing area of the load) 	 Instructed
 CAUTION	
<ul style="list-style-type: none"> ● Do not operate the crane in such a way as to drag the load along the ground. ● Do not leave the crane (or winder, etc.) unattended from an operating position while keeping the load lifted with the clamp. 	 Prohibited
<ul style="list-style-type: none"> ● Raising and lowering operation by crane should be done slowly and carefully. 	 Instructed

5. Maintenance, storage and alteration

 WARNING	
<ul style="list-style-type: none"> ● Never alter the clamp and its accessories. ● Do not apply welding or heat to the clamp or its accessories. ● Do not use any other parts than our company's genuine parts. ● Clamps which require the repair should be stored at a different place so that they are not used mistakenly. 	 Prohibited
<ul style="list-style-type: none"> ● Persons with specialized knowledge designated by the business owner are to conduct maintenance and repairing work. ● When any abnormality with the clamp is found, do not use it and immediately repair or dispose. ● Remove, if any, paint or mud sticking to the moving parts of the clamp, cams, and pads. 	 Instructed
 CAUTION	
<ul style="list-style-type: none"> ● Conduct maintenance and repairing without any load attached. ● Conduct maintenance and repairing after posting a sign indicating that you're on the maintenance work. ● Never fail to lubricate oil on the rotating parts of the clamp (around the pins), guide grooves, sliding parts, etc. ● Be sure to store clamps indoor. 	 Instructed

■ General warning for use (common to all lifting clamp models)

1. Be sure to select proper model clamps for use.
Pay special attentions to keep the lifting direction (rope angle).
2. Confirm the weight of the load. Do not exceed maximum capacity (designated ton) on clamps. (Never overload.)
3. Before use, confirm followings:
 - (a) Proper capacity of clamps.
 - (b) No abnormal movements of clamp or loosening of any bolts.
 - (c) No oil or other foreign matters on the surface of the cam and pad.
4. **Never use for load beyond the clamp range.**
5. When installing clamps, insert a lifting load completely until it comes in contact with the deepest of the jaw opening of main body.
6. **Depending on the model or capacity of the clamp, the cam teeth may not bite a load sufficiently when the load is a hard or light weight material (Less than 1/5 of maximum capacity or less than 1/4 of maximum clamp range). Confirm the condition of clamp for safety.**
7. Confirm that the safety lock is completely engaged in case clamp has a built-in lock.
8. Confirm that the load is well balanced. Determine the clamp position or the center of gravity of the rope properly. It is especially important to determine the horizontal center of gravity.
9. When lifting at 2 points, be sure to use two wire ropes, and make them equal length. (Fig. A)

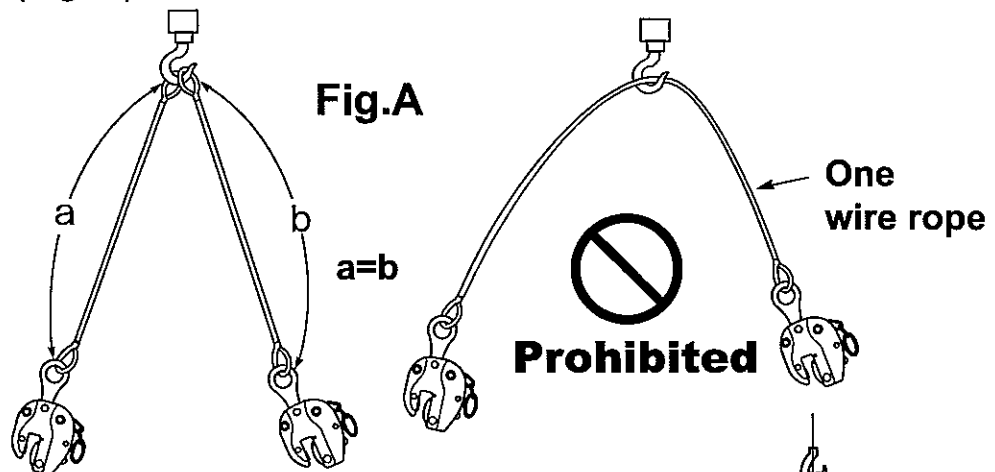

10. When lifting at 2 points, keep the lifting angle within 60° . (Fig. B)
(Follow the standards if lifting angle is specified depending on items.) If the load is long, use a balance.

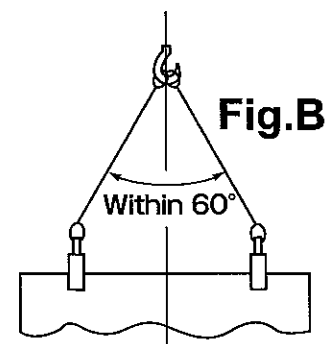

11. Never lift two or more steel plates or steel members at a time.
12. The load may move to an unexpected direction when lifted off the ground and as such confirm the center of gravity and the clamping position for safety when raising. Sufficient caution should be taken until the clamp with the load becomes completely balanced.
13. When changing directions of the load or any similar operations, all personnel must be clear of the area of operation. (Fig. C)

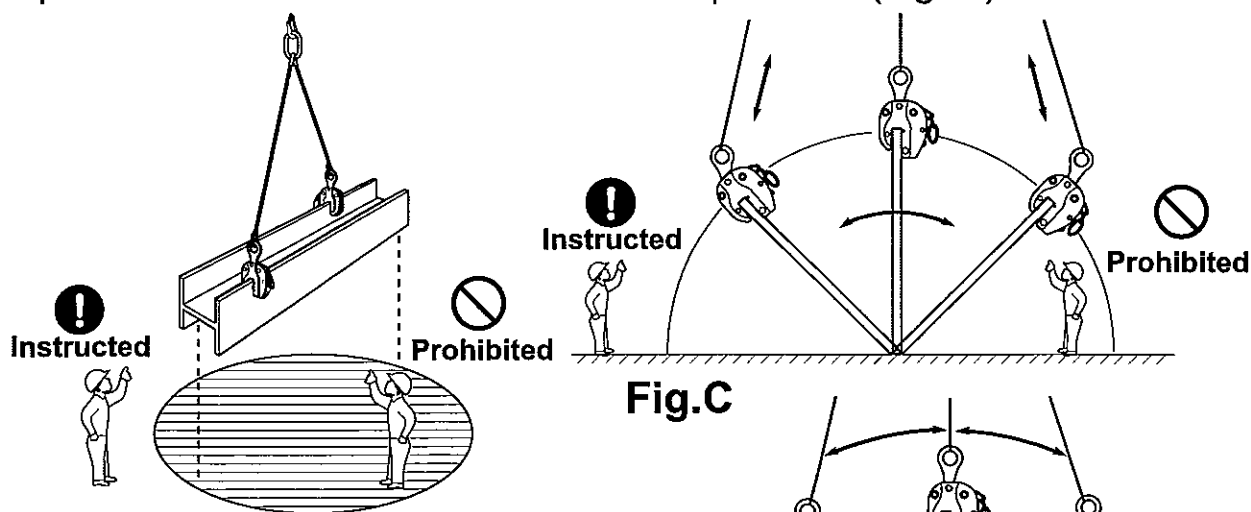

Fig.C

14. Do not ride on the lifting load.
Never use clamp for riding or carrying person.
15. Keep momentary inverting angle of a steel plate within 30°. (Fig. D)

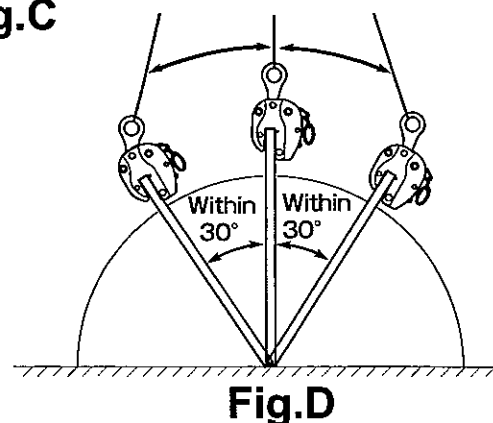

Fig.D

16. **Before operation, the surface of load must always be clean and free of scale, coatings or other foreign matters that will reduce clamping force significantly.**
17. **When raising, special attention must be given to prevent the rope from loosening by its unintended contact with any other objects.**
18. When raising again after the load is put on ground, reconfirm the clamp condition.
19. Do not use clamp for heated load or in a corrosion liquid because safety factor and durability will be reduced in such conditions.
20. Do not alter clamp by welding, cutting by gas or by any other modification.
21. Do not weld electrically a load while being lifted by clamp.
22. Conduct daily maintenance and lubrication.

■ Maintenance and Inspection

1. Maintenance

Daily maintenance is important for efficient and safe operation even under the severe use condition and for such purposes, please comply with the followings.

- (1) Designate the use standards and control.
- (2) Keep clamps indoor and do not leave them outdoor.
- (3) Check the followings to maintain in a good condition.
 - (a) Operating condition.
 - (b) Any abrasion, damage, or clogging at teeth of cam and pad.
 - (c) Deformation of main body - at jaw opening in particular.
- (4) Separate conforming clamps and other hazardous items identified during use or inspection and designate the defective sections. Perform maintenance any soon.
- (5) For the storage, place soft material as wooden chip in-between cam and pad to protect the teeth.
- (6) Perform inspection and maintenance once a week by referring to "Inspection Standards". Lubricate sliding sections periodically. (However, remove oil at teeth of cam and pad.)

2. Periodic Inspection

Perform periodic inspection in accordance with the periodic inspection and maintenance standards. Functions and life of clamps may differ in a great degree as they are used in varieties of fields under different conditions of use. Therefore, preparation and practice of effective handling/inspection standards manual by users themselves are recommended. We ask you to establish complete maintenance and control for assurance of safety in reference to our Manufacturer's Inspection Standards of our clamp. Clamp is designed for easy replacement of parts and therefore, do not fail to replace defective parts. Also, keeping spare parts at all times is recommended. For your preparation of the standards, pay special attention to the followings.

- (1) Operation and maintenance standards
 - (a) Preparation of use criteria (shape of load and operating methods).
 - (b) Thorough understanding and compliance of cautions on handling.
 - (c) Maintenance and storage.
 - (d) Rules of inspection and check at site.

- (2) Standards on periodic inspection
 - (A) Establishing dates of periodic inspection.
 - (B) Establishing inspection and maintenance methods.
 - (a) Inspecting period.
 - (b) Person in charge of the inspection.
 - (c) Inspection site.
 - (d) Tools and devices for inspection.
 - (e) Establishment of permissible limit of use.
 - (f) Explicit designation of maintenance and repair methods.

3. Manufacturer's inspection method

Our company's inspection procedures are as follow.

Check for

- (1) Movements.
- (2) Wear, loss, and/or clogging of/at the teeth of the cam and screw.
- (3) Deformation of main body.
- (4) Deformation of shackle.
- (5) The status of bolts, pins, links and springs.
- (6) Deep scratches in general.
- (7) Other checking items based on the Standards.

Screw Cam Clamp

(Double Eye Type)

SWC-N

■ Uses

Clamps suitable for lifting, suspending, lateral pulling, and turning over steel sheets and shapes in various industries including civil engineering, construction, iron and steel, shipbuilding, and drum manufacturing industries.

It is also ideal for hanging chain blocks, hoists, etc., and pulling of steel materials, etc., as jigs.

■ Features

1. The shackle mounting part is located in two places, vertical and horizontal, so it can be selected depending on the working conditions.
2. It is easy to tighten the screw because the screw is located at the top during the horizontal suspension operation.
3. In proportion to the lifting load, the circular cam tilts and the contact surface becomes larger, clamping firmly.
4. The circular cam is designed whereby the spring forces always make it return to the normal position.
5. The main body is a mold forged product of special alloy steel that is subjected to optimal heat treatment, thus strong and durable.

■ Specifications

Item No.	Maximum Capacity (ton)	Clamp Range (mm)	Net Weight (kg)
SWC 0.5N	0.5	0~25	1.8
SWC 1N	1	0~40	3.2
SWC 2N	2	0~40	5.0

■ REPLACEMENT PARTS AND FITTINGS

Model: SWC-N

PARTS NO.	PARTS NAME			QTY.
	SET	DETAILS	ITEM NO.	
1	SCREW	SCREW	SWCR	1
2	CAM	CIRCULAR CAM	SWT	1
3		STOPPER PIN		2
4		CAM HOLDER		1
5		RETAINING RING		1
6		SPRING		1
7		STEEL BALL		1

Attention

- 1) When ordering, specify the maximum capacity (ton) with ITEM NO.
(For instance, the screw for SWC1N is SWCR1N.)
- 2) Periodic lubrication is regularly required to cam holder and screw.

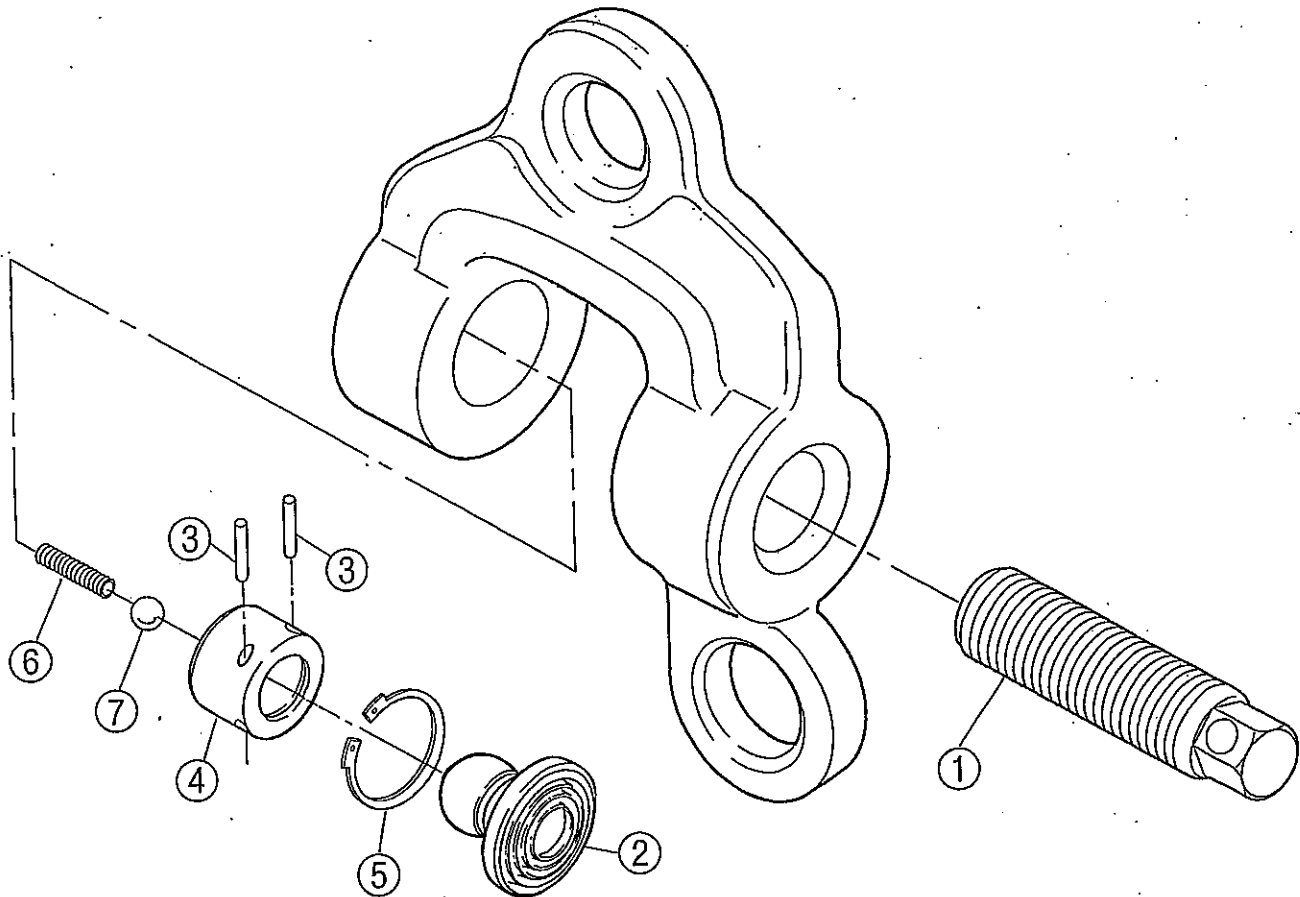

■HOW TO USE

1. OPERATION METHOD

- ① Turn the screw clockwise to close and turn it counterclockwise to open.
(The screw is the right screw.)
- ② When mounting the clamp, insert the lifting load completely until it comes in contact with the deepest of the mouth of the main body. Attach it so that the entire circumference of the inner circumferential teeth of the circular cam hits the surface of the load.
- ③ Tighten the screws of the circular cam until it retreats about 3 mm into the body.

The screw tightening torque should be 25 N·m (about 250 kgf·cm) or more.

- ④ Select a hole (wire rope hole) for mounting a shackle (wire rope) in consideration of the work method and the condition of the lifting load.
- ⑤ Simultaneous use of two holes is prohibited.

Be careful not to loosen the screw against the wire rope or other objects when lifting, etc.

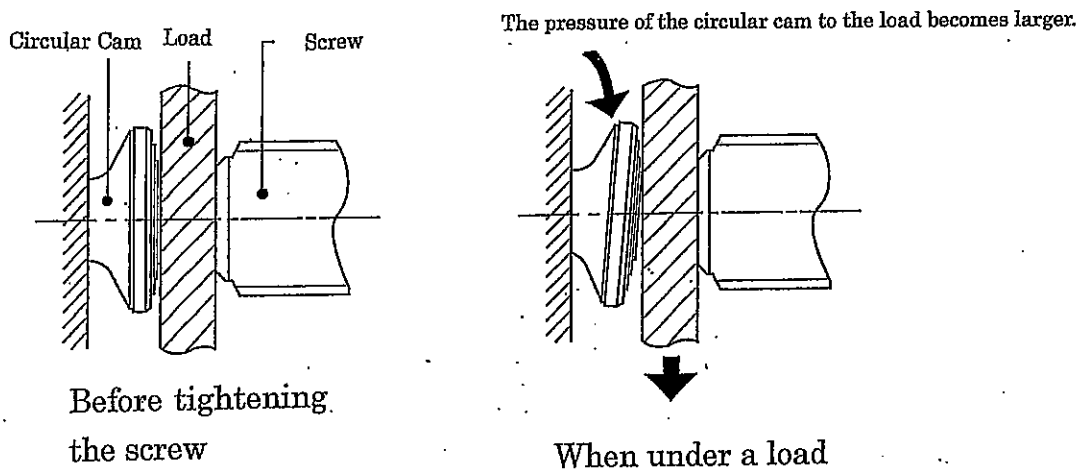
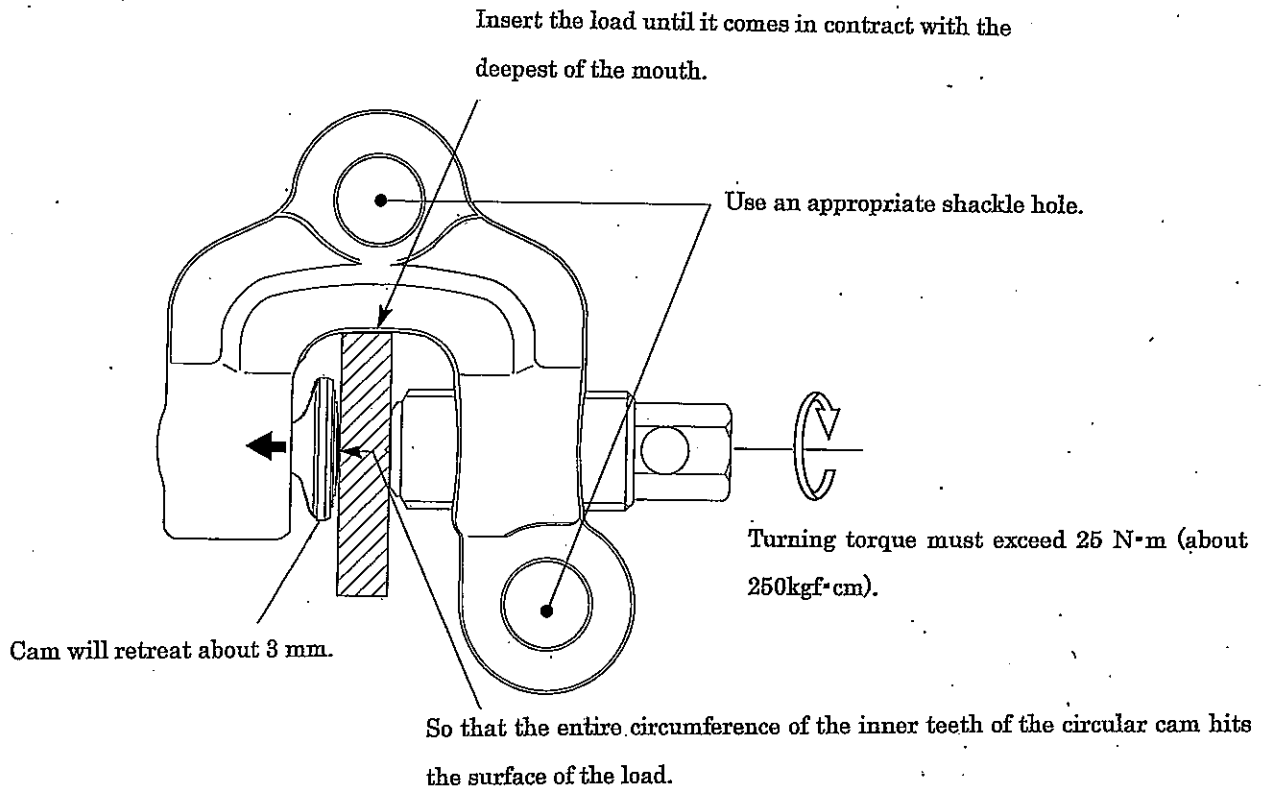

2. METHOD OF USE

- ① When lifting at 2 points, keep the lifting angle within 60° .

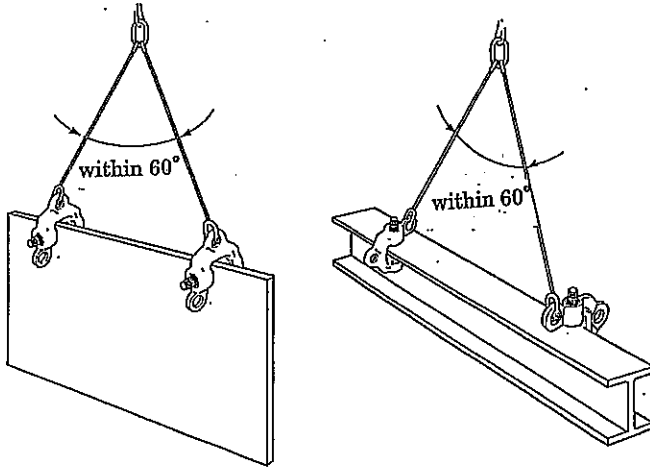

- ② When lifting horizontally, the direction of wire rope should be within the following.

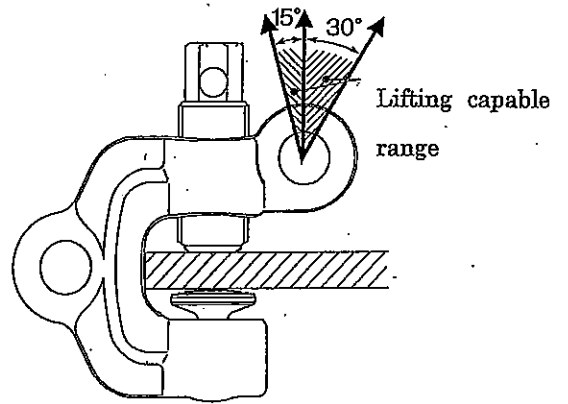

- ③ Always lift at 3 or more points with complicated shaped objects.
(When lifting steel plates horizontally, always lift at 4 points.)

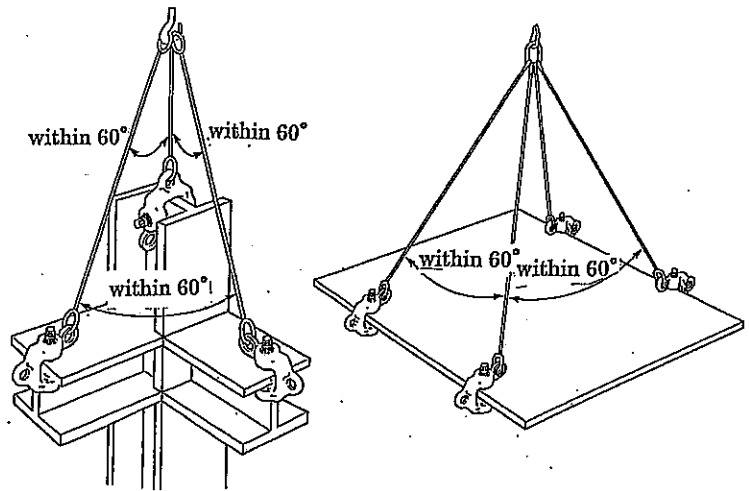

- ④ Used for positioning steel structure for welding, for pulling and for hanging.
(When the clamps are used continuously over a long period of time, check the clamping force regularly at short intervals.)

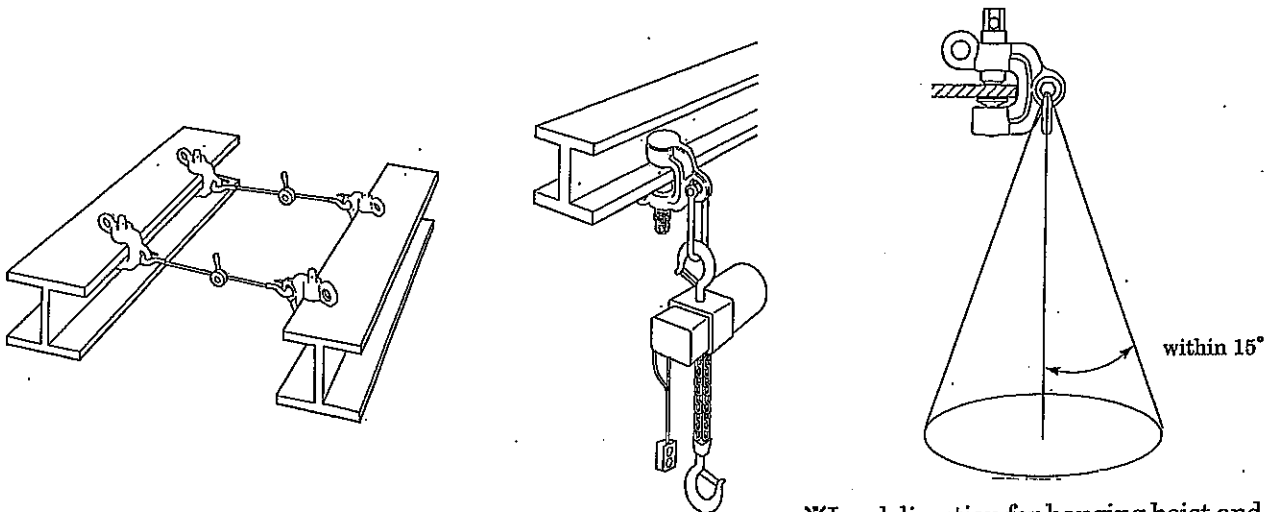

※Load direction for hanging hoist and chain block should be within 15°

The shackle and chain must not

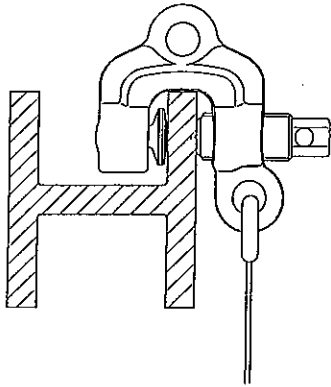

When using H shaped steel, a chain must not interfere with a load.

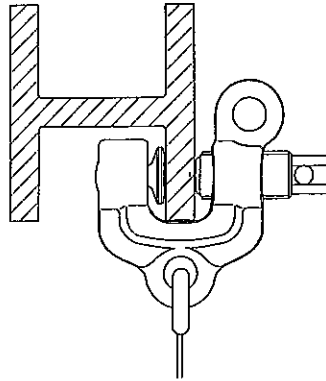

Do not use for the direction clamping from beneath.

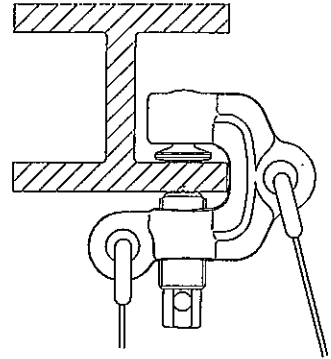

⑤ The clamps can also be used for lifting pipe shaped objects and for turning over objects.

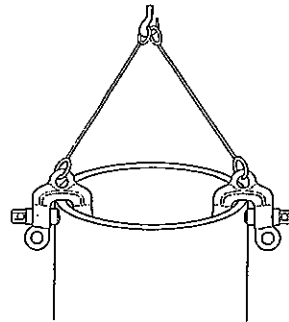
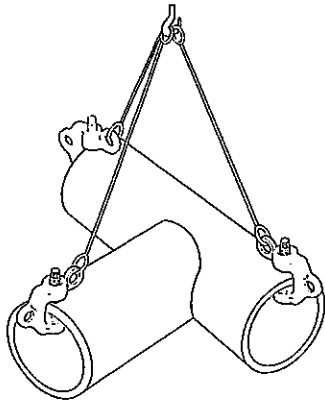

(Cylinder with inner dia. over 600mm.)

⑥ The clamps cannot be used on the following shaped structures.

※Wedge shapes over 8°

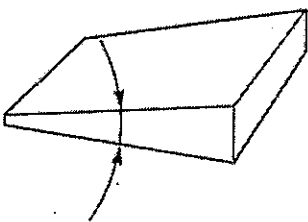

Round bars



Curve shapes with radius under 300mm

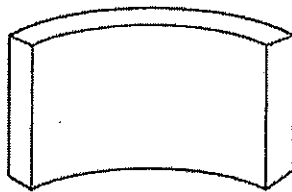

Object with uneven surfaces (no flat surface for clamping) Cylinders with inner dia. under 600mm

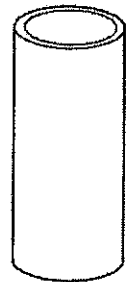
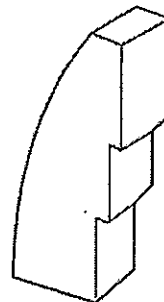

※Even for the case the wedge shapes under 8°, lifting up in tapered down direction is prohibited.

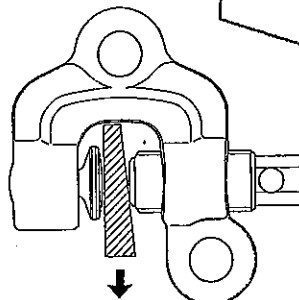

3. DISASSEMBLING AND ASSEMBLING OF PARTS

①How to disassemble

- (1) Turn the screw counterclockwise to pull it out of the main body.
- (2) Tilt the circular cam as shown in the figure on the right. Remove the retaining ring by using a snap ring plier for holes to take out the cam holder, the steel ball and the spring from the main body. (Fig. 1)

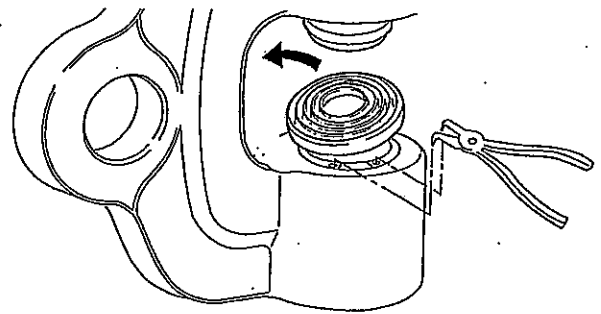

(Fig. 1)

- (3) Take out the two stopper pins from the removed cam holder and remove the circular cam and the retaining ring. (Fig. 2)

②How to Assemble

- (1) Temporarily assemble a retaining ring at the neck of the circular cam.
- (2) Place the spherical part of the circular cam in the cam holder and fix it with two stopper pins.
- (3) Put the spring and steel ball in order in the hole at the bottom of the cam holder of the main body.
- (4) Put the circular cam and the cam holder of (2) into the hole of the main body. At this time, set the steel ball of (3) so that it enters the hole at the bottom of the cam holder.
- (5) Fix the retaining ring of (1) to the groove of the main body using a snap ring plier for holes.
- (6) Tighten the screw into the screw part of the main body.

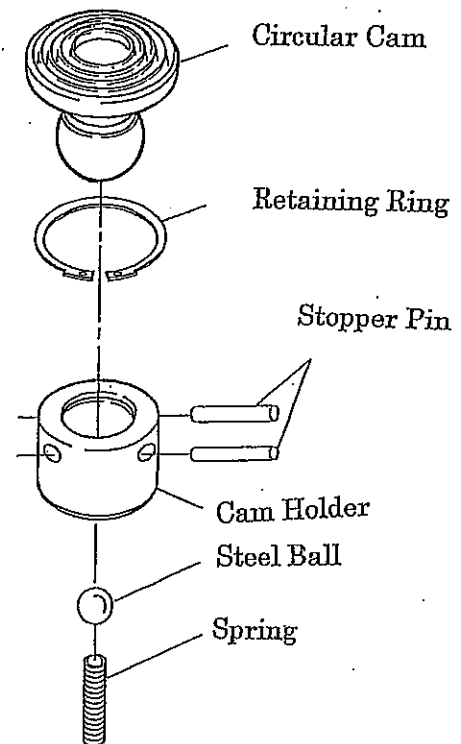

(Fig. 2)

■ CAUTION:

- ◆ Use within the rated capacity.
- ◆ Use within the clamp range.
- ◆ Do not use for any objects other than steel materials.
- ◆ Do not use for hard (30 HRC or higher) load.
- ◆ Lifting is not allowed for a load tapering down in upward direction.
- ◆ Do not apply shock to the load or lifting clamp.
- ◆ Do not lift more than one plate.
- ◆ Before using the product, be sure to check for clogging and wear of the teeth of the cam, screw and any other parts.
- ◆ Do not alter. Heating, modifying, etc. will significantly reduce the quality (strength).

■ OTHER:



- ◆ Inquiries for Repair Parts and Repair.
If repair parts or repairs are required, stop using this clamp and contact your distributor.

■ DAILY INSPECTION:

Conduct daily checks and maintenance to prevent the loss of safety and efficiency.

1. Check that there are no cracks at the body, cam, or wire rope holes.
2. Check if the movement and lubrication condition of each part are good.
3. **Check for wear, loss, or clogging of the teeth of the cam and screw.**
4. Refer to other inspection standards.

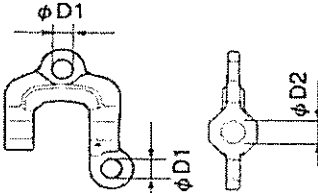
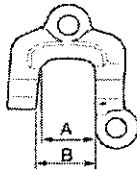
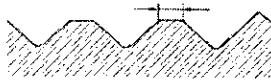
■ INSPECTION STANDARDS

Category	Inspecting Method	Limit of use	Counter-measures												
Body	<ul style="list-style-type: none"> ● Visually check or use color dyes to find cracks. ● Check wear or deformation of shackle and screw hole. (by measuring device) ● Measure the jaw opening. 	<ul style="list-style-type: none"> ● When a crack is found. ● When the hole diameter, even one part of circumference, exceeds the size in the table below. <div style="text-align: center;">  </div> <table border="1" data-bbox="592 526 1174 627" style="margin-left: auto; margin-right: auto;"> <tr> <td>Capacity (ton)</td> <td>0.5</td> <td>1</td> <td>2</td> </tr> <tr> <td>D1 (mm)</td> <td>23</td> <td>27.5</td> <td>34.5</td> </tr> <tr> <td>D2 (mm)</td> <td>27.5</td> <td>27.5</td> <td>27.5</td> </tr> </table> <ul style="list-style-type: none"> ● When the difference between A and B exceeds 5 mm (5%) or more compared to 100 mm in depth. <div style="text-align: center;">  </div> <ul style="list-style-type: none"> ● When the displacement of the center of the forcing screw and cam exceeds 2 mm. 	Capacity (ton)	0.5	1	2	D1 (mm)	23	27.5	34.5	D2 (mm)	27.5	27.5	27.5	Dispose
Capacity (ton)	0.5	1	2												
D1 (mm)	23	27.5	34.5												
D2 (mm)	27.5	27.5	27.5												
Screw	<ul style="list-style-type: none"> ● Visually check or use color dyes to find cracks. ● Visually check the forcing screw for bends or damage. ● Measure the forcing screw for wear or damage. ● Visually check and measure the amount of wear on the top parts. ● Visually check or use color dyes to find crack or flow at the teeth bottom. ● Visually check for broken teeth. 	<ul style="list-style-type: none"> ● When a crack is found. ● When the movement is not smooth, or when the displacement of the screw center exceeds 2mm. ● When thread part on circumference exceeds the size in the table below. <table border="1" data-bbox="592 1238 1174 1308" style="margin-left: auto; margin-right: auto;"> <tr> <td>Capacity (ton)</td> <td>0.5</td> <td>1</td> <td>2</td> </tr> <tr> <td>Diameter (mm)</td> <td>29.3</td> <td>29.3</td> <td>29.3</td> </tr> </table> <ul style="list-style-type: none"> ● When the width of wear exceeds 0.5mm. <div style="text-align: center;">  </div> <ul style="list-style-type: none"> ● When a crack or flow is found. <div style="text-align: center;">  </div> <ul style="list-style-type: none"> ● When one or more broken teeth are found. <div style="text-align: center;">  </div>	Capacity (ton)	0.5	1	2	Diameter (mm)	29.3	29.3	29.3	Replace				
Capacity (ton)	0.5	1	2												
Diameter (mm)	29.3	29.3	29.3												
Spring	<ul style="list-style-type: none"> ● Visually check if cam returns automatically to original position when moved by hands. ● Visually check the clearance of spring. 	<ul style="list-style-type: none"> ● When no repulsive power from deformation and not return to original position. ● When the spring becomes 5% or more shorter than its original length or when the clearance between the coils becomes small. 	Replace												

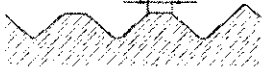
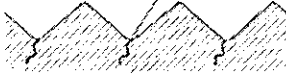
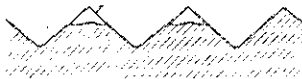
Category	Inspecting Method	Limit of use	Counter-measures								
Circular Cam	<ul style="list-style-type: none"> ● Visually check and measure the amount of wear. ● Visually check or use color dyes to find cracks or flows at the bottom cam teeth. ● Visually check for broken cam teeth. 	<ul style="list-style-type: none"> ● When the amount of wear exceeds 0.5mm.  ● When a crack or flow is found.  ● When one or more broken teeth are found.  	Replace								
Cam Holder	<ul style="list-style-type: none"> ● Measure each section for wear. 	<ul style="list-style-type: none"> ● When the clearance between the body, cam holder and cam becomes large, and exceeds 0.5mm. 	Replace								
Retaining Ring	<ul style="list-style-type: none"> ● Measure for twist and deformation. 	<ul style="list-style-type: none"> ● When the hole diameter, even one part of circumference, exceeds the size in the table below. ● When the twist exceeds 0.3mm. 	Replace								
Stopper Pin	<ul style="list-style-type: none"> ● Measure each section for wear. ● Visually check and measure the forcing for bends, or deformation. 	<ul style="list-style-type: none"> ● When the clearance of chase hole exceeds 0.2mm. ● When the distortion exceeds 0.2mm. ● When the circular cam is not smooth. 	Replace								
Steel Ball	<ul style="list-style-type: none"> ● Measure each section for wear or deformation. 	<ul style="list-style-type: none"> ● When the ball diameter, even one part of the ball, exceeds the size in the table below. <table border="1" data-bbox="587 1563 1173 1635"> <tr> <td>Capacity (ton)</td> <td>0.5</td> <td>1</td> <td>2</td> </tr> <tr> <td>Diameter (mm)</td> <td>4.8</td> <td>4.8</td> <td>5.8</td> </tr> </table> ● When the circular cam is not smooth. 	Capacity (ton)	0.5	1	2	Diameter (mm)	4.8	4.8	5.8	Replace
Capacity (ton)	0.5	1	2								
Diameter (mm)	4.8	4.8	5.8								