

Users Manual

Spring Balancer

ELF-3

ELF-5

ELF-9



For safe and correct operation of the product, please be sure to read this manual and fully understand its content before use.

After reading keep the manual safe so that you can find and use it readily.

In case of resale or transfer of this product, make sure to transfer the manual to the new owner.

CONTENTS

1. Introduction.....	3
Notation in this manual	3
Scope of warranty and liabilities for the equipment	4
Definition of intended users for this manual	4
Emergency contact in case of malfunctions	5
2. Precautions for handling.....	5
3. Unpacking and Installation.....	5
3-1 Packaging arrangement and transportation	5
3-2 Checks after unpacking	5
3-3 Disposal of packing materials	6
4. Product Description	6
4-1 Components	6
4-2 Operating environment	6
4-3 Product specifications	6
4-4 Applicable standards	7
5. Installation	8
5-1 Preparation and checks before installation	8
5-2 Installation procedures	9
5-3 Post-installation checks	10
6. Usage	11
6-1 Pre-operation inspections and checks	11
6-2 Precautions for use.....	12
6-3 Operation method of the drum lock	13
6-4 Replacement of the tools (equipment)	13
6-5 Periodical inspections	14
7. Troubleshooting	15
7-1 Countermeasures?	15
7-2 Releasing the fall-arrest device	15
8. Dimensional Drawing	16
9. Consumables and Special Accessories	16
10. Disposal of Product	16
11. Parts list.....	7-18

1. Introduction



Thank you very much for your purchasing of the Spring Balancer. To prevent any trouble and obtain the best performance, please be sure to read this manual and fully understand its content.

Notation in this manual

Hazard levels

This product is designed with ultimate priority on the safety of operators. However, due to the nature of the system, there are risks that cannot be removed.

In this manual, the level of significance and risk is defined and indicated in three stages: "WARNING", "CAUTION", and "NOTICE". Thoroughly read and fully understand the indicated items before operating the product and performing maintenance procedures. The indications for "WARNING", "CAUTION", and "NOTICE" are in order of risk significance (WARNING > CAUTION > NOTICE). Their details are described below.

 WARNING	A situation that, if mishandled, may cause death or serious disability.
 CAUTION	A situation that, if mishandled, may cause minor or moderate injury.
NOTICE	Indicates a situation that, if mishandled, may cause property damage.

The extent of the problem described above (disability, injury, and property damage) is defined as follows.

Serious disability: Loss of eyesight, wound, burn (high-temperature or low-temperature), electric shock, bone fracture, poisoning, and other injuries that leave aftereffects and that require hospitalization or long-term outpatient treatment.

Moderate injury: Burn, electric shock, bone fracture, and other injuries that do not require hospitalization or long-term outpatient treatment.





Minor injury: Scratch, bruise, laceration, and other injuries that have a minor impact on health.

Property damage: Extended damage to buildings, household articles, and injury to domestic animals or pets.

 **REMINDER**
Describes important details to be remembered for the operation.

Symbols

This Users Manual uses the following symbols to simply provide information in addition to the indications above.

	Indicates a PROHIBITED action that must not be performed.		Indicates potential property damage or a danger that may inflict bodily injury.
	Indicates a REQUIRED action that must be performed.		Indicates that it is necessary to thoroughly read the manual and the relevant documents.

Illustrations

This manual covers multiple models of the Spring Balancer. If their functions and details of operations are identical and can be correctly described in the same way, illustrations are provided taking a specific model as an example. Therefore, please note that the illustrations may be different from the actual equipment.

Scope of warranty and liabilities for the equipment

Warranty and liabilities for the equipment

1. We will repair or replace the product free of charge if a failure due to manufacturing defects occurs under proper usage during the warranty period. For details, contact us or your dealer.
2. The warranty will be void in the following cases:
 - 1) Change of ownership.
 - 2) Repair or modification performed by a party other than the manufacturer, agents, or dealers.
3. The warranty period is one (1) year from the date of purchase.
4. Repairs applicable to any of the following shall be charged even during the warranty period:
 - 1) Failure/damage caused by incorrect use.
 - 2) Failure/damage caused by use of non-authorized parts.
 - 3) Failure/damage caused by fire, earthquake, natural disaster, or other unexpected incident.
 - 4) Incident caused by fall, shock, negligence, or by inadequate storage.
 - 5) Failure/damage caused by use of parts or other equipment that are not included in this product.
 - 6) Replacement of consumables.
 - 7) Usage in violation of dangers or cautions stipulated in this manual.
 - 8) Failure/damage caused by any reason that is not attributable to the manufacturer.
5. Warranty exclusions such as opportunity loss.

Either during or after the warranty period, opportunity loss, damage to anything other than our product(s), or other duties imposed on you/your customer as a result of the failure of our product(s) are outside the scope of the warranty.

Copyright and liabilities

The copyright for this manual is issued to Endo Kogyo Co., Ltd.

The manual is provided for the limited purpose of supporting the safe and proper use of the product. It cannot be used for other purposes.

The customer may not use or make copies of this manual, in whole or in part, outside of this purpose without receiving prior consent from Endo Kogyo Co., Ltd.

The customer is also prohibited from translating or modifying the content of the manual, in whole or in part.

The content described in the manual is subject to change without advance notice. Please note this in advance.

Definition of intended users for this manual

This manual has been prepared to help all intended users involved with this product. From the stand point of safety, we have defined intended users according to their ability and experience and provided detailed descriptions for each group. This manual defines four user levels.

Operator	The operator is a user who engages in general operations. Maintenance and other operations that require special skills are excluded from the general operations. The operator is therefore not permitted to disassemble the main equipment. The operator should read the manual thoroughly and carry out their work with complete understanding of the operating procedures.
Maintenance operator	In addition to the work of the operator described above, the maintenance operator is permitted to perform installation, simple troubleshooting, and periodic inspections. The maintenance operator is required to develop sufficient knowledge and operating skill for this product. The maintenance operator should read the manual thoroughly and carry out their work with complete understanding of the equipment's characteristics and all work contents.







<p>Management supervisor</p>	<p>The management supervisor is required to have sufficient knowledge of the product and advanced operating skill for this product. The management supervisor should manage not only the product itself but on-site operations that handle the product, comprehensively.</p>
<p>Service engineer</p>	<p>In The service engineer is a worker with special knowledge and skills for installing the product, investigating the causes of a failure or damage, and performing repairs and overhauls. Service engineering (the work by the service engineer) is performed by our service technicians or authorized service technicians.</p>

Emergency contact in case of malfunctions

If any problem with the product arises, contact us or your dealer.

2. Precautions for handling

Incorrect handling of this product may cause damage to the product itself as well as a fire or injury. Thoroughly read the following precautions and be sure to heed the instructions when handling the machinery.

 WARNING	
	<ul style="list-style-type: none"> • Do not use in explosive, flammable gas, or dusty atmospheres, any place where water or oil may splash, and near combustibles. This may cause fire or injury. • Do not perform any modification of the product.
	<p>The maintenance should be performed by a maintenance operator who has developed sufficient knowledge and operating skill for the balancer.</p>
	<ul style="list-style-type: none"> • Incorrect usage of the product may cause an injury. Use the product correctly in accordance with the descriptions in this manual. • Particularly, “WARNING”, “CAUTION”, and “NOTICE” described in this manual must be fully understood and always observed. • Install the product correctly in accordance with the descriptions in this manual.
 CAUTION	
	<ul style="list-style-type: none"> • Be sure to perform daily and periodic inspections. • Be sure to use the product within the capacity range that is described in “4-3-1 Specifications”.

3. Unpacking and Installation

3-1 Packaging arrangement and transportation

The standard set of this product is packaged for delivery in a cardboard box. The total weight of the package is the sum of the weight described in “4-3-1 Specifications” and the weight of the packing materials (approximately 0.5 kg). When transporting the package, do not drop or allow impact to it. Prepare a box of a similar size for re-packaging.

3-2 Checks after unpacking

After opening the package, check that the following products are included. Please contact us if you find anything missing or damaged.

- Spring Balancer (main equipment) ---- 1 set
- Support Site guide or Users Manual--- 1 copy

3-3 Disposal of packing materials

After opening the package, dispose of any packing and cushioning materials in accordance with the local regulations of the area where the product is used.

4. Product Description

4-1 Components

4-1-1 Main equipment (ELF-3,5,9)

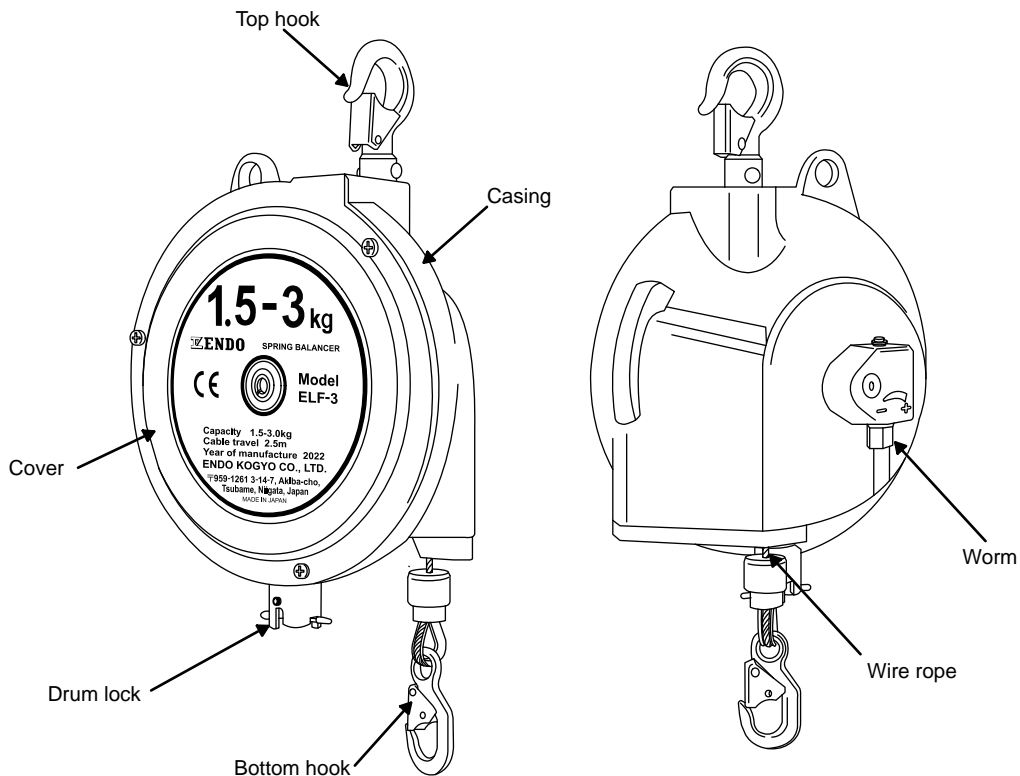

4-2 Operating environment

Installation location:	General indoor
Ambient temperature:	-10°C to +50°C (no freezing)
Humidity:	85% or less (no condensation)
Atmosphere:	Non-explosive, free of flammable or corrosive gas, or dust, water/oil should not splash directly

4-3 Product specifications

4-3-1 Specifications

Model	Capacity range (kg)	Factory setting load (kg)	Stroke (m)	Wire rope diameter (φ mm)	Mass (kg)
ELF-3	1.5~3.0	2.3	2.5	3.0	Approx. 4.6
ELF-5	3.0~5.0	4.0	2.5	3.0	Approx. 4.8
ELF-9	5.0~9.0	7.0	2.5	3.0	Approx. 5.4

4-3-2 Fall-arrest device

If the spring is ruptured, this device prevents the tool (equipment) attached to the bottom hook from falling across the entire stroke. If the spring is ruptured, the safety pin is activated from the spring casing and interferes (collides) with the pin installed on the spring casing, stopping the rotation of the drum. For the method of releasing the activated fall-arrest device, refer to “7-2 Releasing the fall-arrest device”.

CAUTION



The fall-arrest device is not designed to prevent tools (equipment) from falling. Before using the balancer, be sure to check that the total mass (weight) of the tool (equipment) and the accessories is within the capacity range of the balancer.

NOTICE

If the spring tension is set lower than the minimum capacity, the fall-arrest device will be activated and prevent the vertical movement of the tool (equipment). (See “0 Installation of tools (equipment) and adjustment of the spring tension”.)

4-3-3 Drum lock device

You can lock the drum by setting the drum lock device. (See “6-3 Operation method of the drum lock”.) The drum lock is used to remove the tool (equipment) attached to the bottom hook or to replace the wire rope or the wire guide. (See “6-4-1 Method of removing the tool (equipment)”.)

4-4 Applicable standards

■ Machinery Directive 2006/42/EC

EN ISO 12100 : Safety of machinery General principles for design Risk assessment risk reduction

Note: Only the standard specification of this product complies with the standards. If the product is used in combination with non-standard parts or modified by the customer, the standards may no longer be complied with. Please note this in advance.

5. Installation

WARNING



- Install the balancer correctly in accordance with the descriptions in this manual. Incorrect installation may cause an injury, property damage, or damage to the balancer.
- Be sure to attach an auxiliary wire rope or chain to the balancer to protect workers in case the top hook or the support member (metal hanger) for the balancer should be damaged.

CAUTION

The installation should be performed by a maintenance operator who has developed sufficient knowledge and operating skill for the balancer.

5-1 Preparation and checks before installation

5-1-1 Tools and equipment for installation

All of the following items must be prepared by the customer.

- Auxiliary wire rope or chain
- Support members (metal hangers)

5-1-2 Check of installation location

Before installing the product, check that the installation location does not have any of the following problems.

- 1 Check that the support members have a sufficient strength.
- 2 Ensure that sufficient space for performing maintenance, including the adjustment of the spring tension, is available on a side of the main equipment.
- 3 Ensure that adequate work space is available around the main equipment.
- 4 Check that the installation location has the installation environment described in "4-2 Operating environment".
- 5 If a trolley is used, attach a carabiner.
- 6 Check that there are no sharp edges in the installation location.

5-2 Installation procedures

5-2-1 Installation of the Spring Balancer

⚠ CAUTION

 Do not fix the top hook. Using the product with the top hook fixed may cause damage or a fall.

NOTICE

 Use a support member (metal hanger) with no opening as shown in the figure on the right, so that the balancer does not come off while in motion.

- Attach the support member such that the balancer does not collide with its surroundings.
- When installing multiple balancers alongside, place them at different heights so that they do not collide with each other.

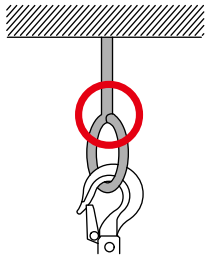

- 1 Prepare a support member (metal hanger) with a sufficient strength. Attach the top hook of the balancer directly to the support member (metal hanger).

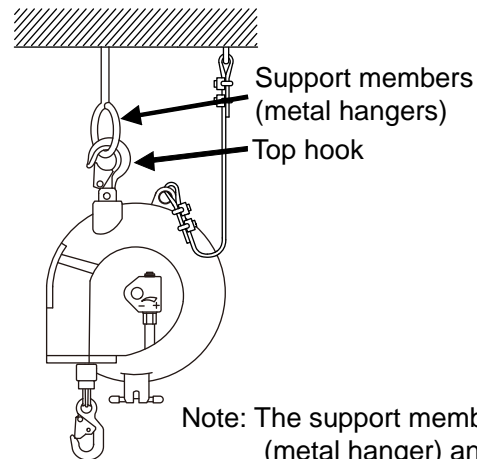

Note: The support member (metal hanger) and the tool (equipment) in the figure are indicated for reference.

- 2 Check that the top hook latch is closed.
- 3 Ensure that the balancer moves freely.
- 4 Prepare an auxiliary wire rope or chain that has a strength at least 10 times greater than the maximum capacity of the balancer.
- 5 As shown in the figure on the right, attach an end of the auxiliary wire rope or chain to a support member (metal hanger) different from the support member (metal hanger) to which the top hook has been attached. Attach the other end of the auxiliary wire rope or chain to the main equipment of the balancer.

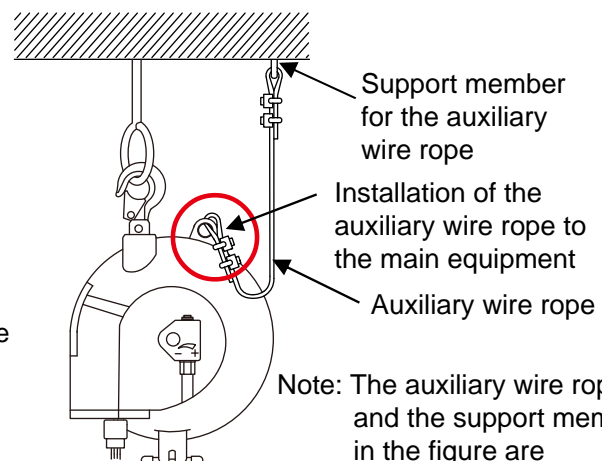

Note: The auxiliary wire rope and the support member in the figure are indicated for reference.

⚠ CAUTION

Loosen the auxiliary wire rope or chain to allow the balancer to move freely.

The slack must be such that the balancer stops within 100 mm if the top hook or the support member (metal hanger) for the balancer are damaged and the balancer falls.

5-2-2 Installation of tools (equipment) and adjustment of the spring tension

⚠ WARNING

Do not pull out the wire rope when the balancer is not loaded. If the wire rope is released by mistake while being pulled out without a load, it may quickly be wound up, causing an injury.

NOTICE

If the spring tension is set higher than the maximum capacity, not only will the specified stroke not be obtained, but the life of the spring will also be reduced. Also, if the spring tension is set lower than the minimum capacity, the fall-arrest device will be activated and prevent the vertical movement of the tool (equipment).

- 1 Check whether the total mass (weight) of the tool (equipment) and the accessories is within the capacity range of the balancer.
- 2 Lift the tool (equipment) and attach it to the bottom hook of the balancer. Do not pull out the wire rope.
 - The tension will increase if you turn the worm in the “+” direction (clockwise).
 - The tension will decrease if you turn the worm in the “-” direction (counterclockwise).
- 3 Lift the tool (equipment) and attach it to the bottom hook of the balancer. Do not pull out the wire rope.
- 4 After attaching the tool (equipment), perform readjustment and ensure that balance is achieved.

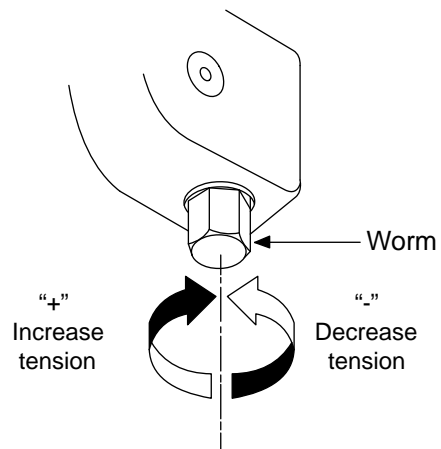

NOTICE

If the spring tension is too strong, the main equipment of the balancer or the wire rope may be damaged.

5-3 Post-installation checks

5-3-1 Checking the working range (stroke)

NOTICE	
	Do not extend the wire rope beyond the stroke. Doing so may damage the balancer.

- 1 Ensure that work can be performed within the range of the stroke. For the stroke of each product, see “4-3-1 Specifications”.
- 2 If the range of the stroke is insufficient, lower the installation height of the balancer or use an appropriate sling between the bottom hook and the tool (equipment).

Note: The auxiliary wire rope, the support member, and the tool (equipment) in the figure are indicated for reference.

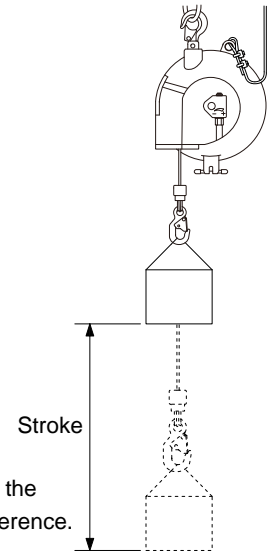

6. Usage

6-1 Pre-operation inspections and checks

WARNING	
	If any abnormality is found as a result of inspection, do not use the balancer.
	If the range of the stroke is insufficient, lower the installation height of the balancer or use an appropriate sling between the bottom hook and the tool (equipment).

Inspect and check the following items before starting the operation:

■ Check of the surroundings

- 1 Ensure that there is no trash or unnecessary equipment around the balancer or in the work space.
- 2 If there is any obstacle and the like that cannot be removed, contact the person in charge of the work.

■ Inspection of the support member (metal hanger)

- 1 Check that the support member (metal hanger) is not worn.
- 2 If any wear is found, immediately stop the operation.

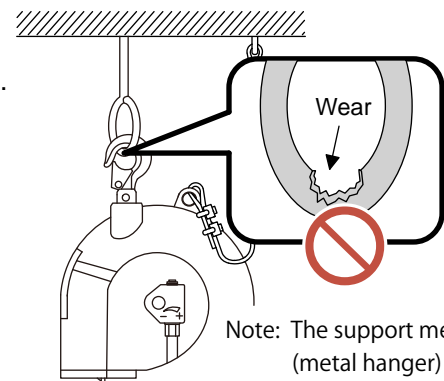

Note: The support member (metal hanger) in the figure is indicated for reference.

■ Check of the main equipment of the balancer

For the main equipment of the balancer, perform the following inspections and checks.

- 1 Check that the top and bottom hooks are not worn and can rotate smoothly.
- 2 Check that the latches of the top and bottom hooks are not deformed and do not come off the hooks.
- 3 Check that the wire rope is not worn (Note: particular attention should be paid to wire breakage and the base of terminal locks).
- 4 Check that the buffer is not worn or cracked.
- 5 Check that the case is not worn, the mounting bolts are not loose, and air is not leaking.
- 6 Check that the auxiliary wire rope (or chain) is not worn and the mounting bolts are not loose.
- 7 Check the E-type retaining ring is not removed.
- 8 Check that the screws and the bolts in various parts are not loose.

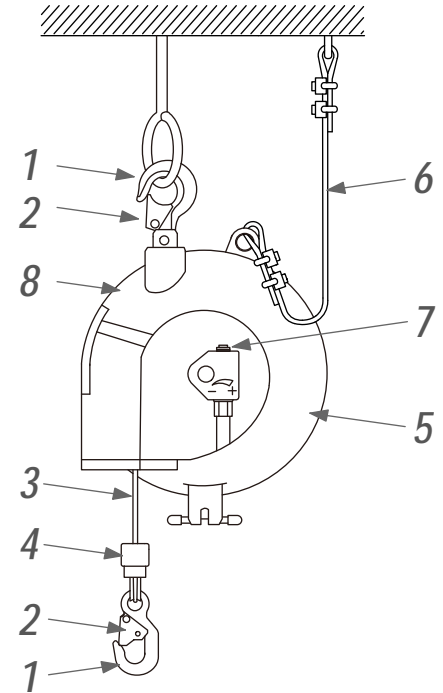

Note: The support member (metal hanger) and the auxiliary wire rope in the figure are indicated for reference.

6-2 Precautions for use

⚠ WARNING



- Do not move directly under the tool (equipment) suspended from the balancer.
- Do not perform any modification of the balancer.
- Do not remove tools (equipment) with the wire rope pulled out. The wire rope may be quickly wound up, causing an injury.

CAUTION

⚠ CAUTION



Be sure to use the product within the capacity range. (Refer to the capacity range in "4-3-1 Specifications")

NOTICE



- Do not extend the wire rope further than its stroke.
- Do not extend the wire rope in an oblique direction.



Adjust the spring tension before the operation.

Remove the tool (equipment) while lifting it and with the wire rope completely wound inside the drum.

6-3 Operation method of the drum lock

Operate the drum lock according to the figure below.

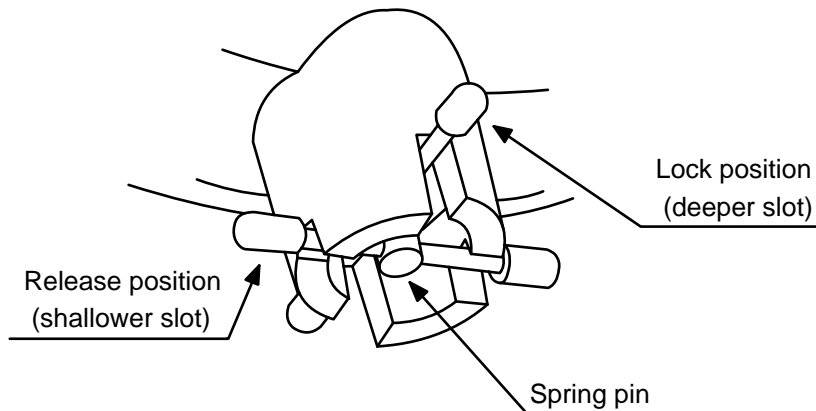

6-3-1 Activation of the drum lock

⚠ WARNING



- Do not remove the tool (equipment) attached to the bottom hook until it is confirmed that the drum is securely locked. If the drum is locked inadequately, the drum lock may be released during the work. Then, the wire rope may be quickly wound up, causing an injury.

- 1 Remove the spring pin from the release position and move it to the lock position.
- 2 Move the tool (equipment) up and down to check that the drum is securely locked.

6-3-1 Activation of the drum lock

⚠ WARNING



- Do not release the drum lock when the balancer is not loaded or after the tool (equipment) is replaced with one with a different mass (weight). If the drum lock is released in such situations, the wire rope may be quickly wound up as soon as the lock is released, the tool may fall, or an injury may be caused. Attach the tool and adjust the spring tension before releasing the drum lock.

- 1 If the tool has been removed, be sure to attach the removed tool.
- 2 Remove the spring pin from the lock position and move it to the release position.

6-4 Replacement of the tools (equipment)

6-4-1 Method of removing the tool (equipment)

⚠ WARNING



- Do not move directly under the tool (equipment) suspended from the balancer.
- Do not remove tools (equipment) with the wire rope pulled out. The wire rope may be quickly wound up, causing an injury.

- 1 Confirm that the tool (equipment) can be moved up and down.
- 2 Lift the tool and wind the wire rope completely inside the drum.
- 3 Remove the tool (equipment).

6-4-2 Method of attaching the tool (equipment)

WARNING



- Do not move directly under the tool (equipment) suspended from the balancer.

CAUTION

Be sure to use the product within the capacity range. (Refer to the capacity range in “4-3-1 Specifications”)

NOTICE



Adjust the spring tension before the operation.

- 1 Check whether the total mass (weight) of the tool (equipment) and the accessories is within the capacity range of the balancer.
- 2 Install the tool (equipment) and adjust the spring tension in accordance with “0 Installation of tools (equipment) and adjustment of the spring tension”.

6-4-3 Replacement of the tool (equipment) using the drum lock

WARNING



- Do not move directly under the tool (equipment) suspended from the balancer.
- Do not replace the tool with one with a different mass.
- Do not remove the tool before checking that the drum is securely locked by moving the tool (equipment) up and down. If the drum is locked inadequately, the drum lock may be released during the work. Then, the wire rope may be quickly wound up, causing an injury.

CAUTION



Be sure to use the product within the capacity range. (Refer to the capacity range in “4-3-1 Specifications”)

NOTICE



Adjust the spring tension before the operation.

- 1 Confirm that the tool (equipment) can be moved up and down.
- 2 Lock the drum within the range of the stroke according to “6-3 Operation method of the drum lock”, and then remove the tool.
- 3 Confirm that the mass of the tools is identical, and attach the tool (equipment) according to “0 Installation of tools (equipment) and adjustment of the spring tension”.

6-5 Periodical inspections

Perform an inspection at least once per month.

For the method of the periodical inspections, download “Repair Manual” from our website and refer to “2-2 Periodical inspections” in “Repair Manual”.

<http://www.endo-kogyo.co.jp>

If the product is used in an unfavorable environment or used frequently, reduce the interval between the inspections.

7. Troubleshooting

7-1 Countermeasures?

WARNING



- Do not remove the tool (equipment) attached to the wire rope end until the cause of the failure is identified. If the tool (equipment) is removed, the wire rope may be quickly wound up, causing an injury.

CAUTION



- If you notice anything unusual, stop the operation immediately. After checking the items listed in the table below, appropriate measures should be taken by a maintenance operator who has developed sufficient knowledge and operating skill for the balancer.
- If the situation does not relate to any of the listed items in the table below, contact us or your dealer.

Failure	Reason	Measure
• The wire rope cannot be pulled out or wound.	• The drum lock is activated.	• Release the drum lock. See "6-3 Operation method of the drum lock".
	• The spring tension is increased too much and the spring has been tightly wound.	• Decrease the spring tension. See "0 Installation of tools (equipment) and adjustment of the spring tension".
	• The spring tension is decreased too much and the fall-arrest device has been activated.	• Release the fall-arrest device. See "7-2 Releasing the fall-arrest device".
	• The wire rope came off the groove on the drum and is caught between the casing and the drum.	• Return the wire rope to the groove on the drum.
	• The spring has been ruptured.	• Replace the spring. See "2-4 Replacement of the spring" in "Repair Manual".

7-2 Releasing the fall-arrest device

If the fall-arrest device is activated, for example, when the spring tension is reduced too much, release the fall-arrest device with the following procedure.

- 1 Move the tool (equipment) up and down manually.
The tool can be moved up and down within approximately 70 mm to 160 mm.
- 2 If the tool descends after being lifted up by hand and then released, turn the worm in the "+" direction (clockwise) until the tool starts ascending. At this time, never remove the tool.
- 3 Confirm that the tool can be moved up and down, and that the fall-arrest device is released.
- 4 If the fall-arrest device cannot be released with the procedure above, the spring is ruptured. Replace the spring according to "2-4 Replacement of the spring" in "Repair Manual".

8. Dimensional Drawing

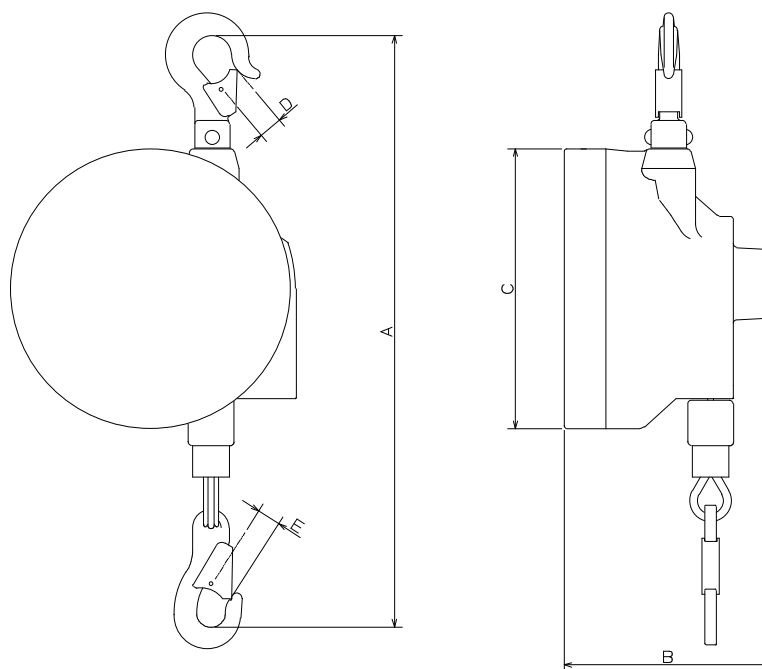

Outline drawing (Table of external dimensions)

Model	Dimension (mm)					
	A		B	C	D	E
	MIN.	MAX.				
ELF-3	374	2874	130	Φ 221	14	15
ELF-5	374	2874	130	Φ 221	14	15
ELF-9	374	2874	130	Φ 221	14	15

9. Consumables and Special Accessories

The consumables include the following parts. If any of these parts are broken or any wear or damage is found, replace them.

- Spring
- Wire rope
- Wire guide
- Drum

Note: For the replacement of the consumables and other parts, download "Repair Manual" from our website or contact us or your dealer.

For special accessories of the Spring Balancer, check in the catalog linked on our website.

Our website: <http://www.endo-kogyo.co.jp/>

10. Disposal of Product

When disposing of the product, follow the local regulations of the area where the product to be disposed, and dispose it as industrial waste.

11. Parts list

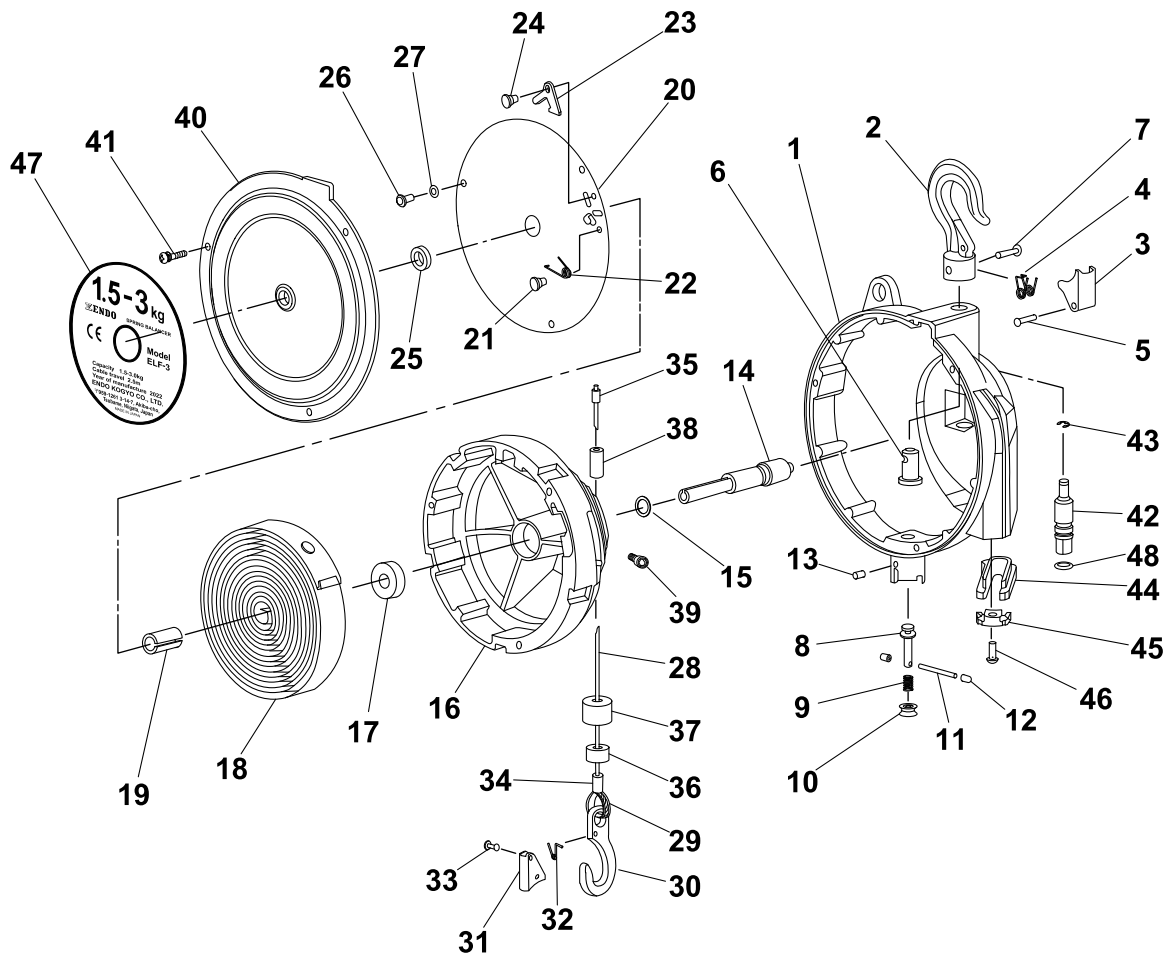

■ How to find the parts from the list

Please refer the reference number on the exploded view and choose the parts from the list according to its reference number

Ref.No.	Part No.	Description	Quantity		
			EWS-3	EWS-5	EWS-7
-	LBP000749	Casing assembly	1	1	1
1	P2B100109	—Casing	1	1	1
-	LBP000241	—Hook complete	1	1	1
2	-	---Hook	1	1	1
-	LBP000240	---Latch set	1	1	1
3	-	----Latch	1	1	1
4	-	----Spring	1	1	1
5	-	----Rivet	1	1	1
6	-	---Shaft	1	1	1

The mark indicates the range of the set or the complete unit.

● How to order the parts

Please inform us or our distributors of the parts information which include the model, part description, parts number and quantity.

Example

model: ELF-3 parts name: drum parts number: P2B100140 quantity: 1

Spring Balancer Users Manual

Ref.No.	Part No.	Description	Quantity		
			ELF-3	ELF-5	ELF-9
-	LBP001317	Casing assembly	1	1	1
1	P2B100141	- Casing	1	1	1
-	LBP000262	- Hook complete	1	1	1
2	-	-- Hook	1	1	1
-	LBP000263	-- Latch set	1	1	1
3	-	--- Latch	1	1	1
4	-	--- Spring	1	1	1
5	-	--- Rivet	1	1	1
6	-	-- Shaft	1	1	1
7	-	-- Rivet	1	1	1
-	LBP001318	Drum lock assembly	1	1	1
8	-	- Pin	1	1	1
9	-	- Spring	1	1	1
10	-	- Collar	1	1	1
11	-	- Spring pin	1	1	1
12	P2B400348	Cap	2	2	2
13	P2B400041	Set screw	1	1	1
14	P2B300957	Spindle	1	1	1
15	P2B401573	O-ring	1	1	1
16	P2B100140	Drum	1	1	1
17	KA60104010	Ball bearing	1	1	1
18	P2B300950	Spring	1	-	-
18	P2B300951	Spring	-	1	-
18	P2B300952	Spring	-	-	1
19	P2B401587	Bushing	1	1	1
-	LBP001299	Disc assembly	1	1	1
20	-	- Cover	1	1	1
21	-	- Rivet	1	1	1
22	-	- Spring	1	1	1
23	-	- Stopper	1	1	1
24	-	- Rivet	1	1	1
25	P2B401579	Bushing	1	1	1
26	KA10120512	Screw	3	3	3
27	KA31120500	Spring washer	3	3	3
-	LBP001300	Wire rope assmbly	1	1	1
28	-	- Wire rope	1	1	1
29	-	- Thimble	1	1	1
-	LBP001505	- Hook complete	1	1	1
30	-	-- Hook	1	1	1
-	LBP001524	-- Latch set	1	1	1
31	-	--- Latch	1	1	1
32	-	--- Spring	1	1	1
33	-	--- Rivet	1	1	1
34	-	-- Lock tube	1	1	1
35	-	-- Lock tube	1	1	1
36	P2B400149	- Collar	1	1	1
37	P2B400146	- Buffer	1	1	1
38	P2B401575	Bushing	1	1	1

Spring Balancer Users Manual

Ref.No.	Part No.	Description	Quantity		
			ELF-3	ELF-5	ELF-9
39	P2B401619	Screw	1	1	1
40	P2B200190	Cover	1	1	1
41	P2B400860	Screw	3	3	3
42	LBP300446	Worm	1	1	1
43	KA40310050	Retaining ring	1	1	1
-	LBP001021	Wire guide set	1	1	1
44	-	- Wire guide	1	1	1
45	-	- Wire guide	1	1	1
46	P2B401213	- Hex.socket button bolt	2	2	2
47	P2B300954	Name plate	1	-	-
47	P2B300955	Name plate	-	1	-
47	P2B300956	Name plate	-	-	1
48	KA50200140	O-ring	1	1	1

NOTE) When placing an order, clearly specify the product model, part number and description.
 Parts without a part number cannot be supplied individually.
 Please purchase a set or complete unit.

ENDO 遠藤工業株式会社

〒959-1261 新潟県燕市秋葉町3丁目14番7号

<http://www.endo-kogyo.co.jp>

本社営業部 〒959-1261 新潟県燕市秋葉町3丁目14番7号

TEL : 0256-62-5133

FAX : 0256-62-5772

エコファクトリー 〒959-1276 新潟県燕市小池5181番地1

TEL : 0256-63-9306

FAX : 0256-63-4393

東京営業部 〒101-0042 東京都千代田区神田東松下町12番2号JBSL神田ビル2F

TEL : 0256-63-9306

FAX : 0256-63-4393

名古屋営業所 〒460-0011 愛知県名古屋市中区大須1丁目7番14号パークIMビル3F

TEL : 052-253-6231

FAX : 052-253-6240

大阪営業部 〒556-0021 大阪府大阪市浪速区幸町2丁目3番14号ダイトービル3F

TEL : 052-253-6231

FAX : 052-253-6240

九州営業所 〒812-0013 福岡県福岡市博多区博多駅東3丁目11番15号文喜ビル3F

TEL : 052-253-6231

FAX : 052-253-6240

サービス営業グループ 〒959-1261 新潟県燕市秋葉町3丁目14番7号

TEL : 0256-64-4786

FAX : 0256-62-5772

E-mail : service@endo-kogyo.co.jp

ENDO KOGYO CO., LTD

3-14-7, Akiba cho, Tsubame, Niigata 959-1261, Japan

<http://www.endo-kogyo.co.jp> TEL : 81-256-62-5133

- 本書ならびに本製品の仕様は改善のために予告なしに変更することがあります。
- 本書の内容の無断転載を禁止します。
- This manual and the specifications of this product are subject to change for improvement without advance notice.
- It is strictly prohibited to reprint or copy any information contained in this manual.



Repair Manual

Spring Balancer

ELF-3

ELF-5

ELF-9



For safe and correct operation of the product, please be sure to read this manual and fully understand its content before use.

After reading keep the manual safe so that you can find and use it readily.

In case of resale or transfer of this product, make sure to transfer the manual to the new owner.

Introduction



Thank you very much for your purchasing of the Spring Balancer. To prevent any trouble and obtain the best performance, please be sure to read this manual and fully understand its content.

Notation in this manual

Hazard levels

This product is designed with ultimate priority on the safety of operators. However, due to the nature of the system, there are risks that cannot be removed.

In this manual, the level of significance and risk is defined and indicated in three stages: "WARNING", "CAUTION", and "NOTICE". Thoroughly read and fully understand the indicated items before operating the product and performing maintenance procedures. The indications for "WARNING", "CAUTION", and "NOTICE" are in order of risk significance (WARNING > CAUTION > NOTICE). Their details are described below.

 WARNING	A situation that, if mishandled, may cause death or serious disability.
 CAUTION	A situation that, if mishandled, may cause minor or moderate injury.
NOTICE	Indicates a situation that, if mishandled, may cause property damage.

The extent of the problem described above (disability, injury, and property damage) is defined as follows.

Serious disability: Loss of eyesight, wound, burn (high-temperature or low-temperature), electric shock, bone fracture, poisoning, and other injuries that leave aftereffects and that require hospitalization or long-term outpatient treatment.

Moderate injury: Burn, electric shock, bone fracture, and other injuries that do not require hospitalization or long-term outpatient treatment.

Minor injury: Scratch, bruise, laceration, and other injuries that have a minor impact on health.





Property damage: Extended damage to buildings, household articles, and injury to domestic animals or pets.

Other than WARNING, CAUTION, and NOTICE described above, matters important to workers are indicated using the following format.

 REMINDER	Describes important details to be remembered for the operation.
---	---

Symbols

This Users Manual uses the following symbols to simply provide information in addition to the indications above.

	Indicates a PROHIBITED action that must not be performed.		Indicates potential property damage or a danger that may inflict bodily injury.
	Indicates a REQUIRED action that must be performed.		Indicates that it is necessary to thoroughly read the manual and the relevant documents.

Illustrations

This manual covers multiple models of the Spring Balancer. If their functions and details of operations are identical and can be correctly described in the same way, illustrations are provided taking a specific model as an example. Therefore, please note that the illustrations may be different from the actual equipment.

Scope of warranty and liabilities for the equipment

Warranty and liabilities for the equipment

1. We will repair or replace the product free of charge if a failure due to manufacturing defects occurs under proper usage during the warranty period. For details, contact us or your dealer.
2. The warranty will be void in the following cases:
 - 1) Change of ownership.
 - 2) Repair or modification performed by a party other than the manufacturer, agents, or dealers.
3. The warranty period is one (1) year from the date of purchase.
4. Repairs applicable to any of the following shall be charged even during the warranty period:
 - 1) Failure/damage caused by incorrect use.
 - 2) Failure/damage caused by use of non-authorized parts.
 - 3) Failure/damage caused by fire, earthquake, natural disaster, or other unexpected incident.
 - 4) Incident caused by fall, shock, negligence, or by inadequate storage.
 - 5) Failure/damage caused by use of parts or other equipment that are not included in this product.
 - 6) Replacement of consumables.
 - 7) Usage in violation of dangers or cautions stipulated in this manual.
 - 8) Failure/damage caused by any reason that is not attributable to the manufacturer.
5. Warranty exclusions such as opportunity loss.

Either during or after the warranty period, opportunity loss, damage to anything other than our product(s), or other duties imposed on you/your customer as a result of the failure of our product(s) are outside the scope of the warranty.

Copyright and liabilities

The copyright for this manual is issued to Endo Kogyo Co., Ltd.

The manual is provided for the limited purpose of supporting the safe and proper use of the product. It cannot be used for other purposes.

The customer may not use or make copies of this manual, in whole or in part, outside of this purpose without receiving prior consent from Endo Kogyo Co., Ltd.

The customer is also prohibited from translating or modifying the content of the manual, in whole or in part.

The content described in the manual is subject to change without advance notice. Please note this in advance.

Definition of intended users for this manual

This manual has been prepared to help all intended users involved with this product. From the stand point of safety, we have defined intended users according to their ability and experience and provided detailed descriptions for each group.

This manual defines four user levels.

Operator	The operator is a user who engages in general operations. Maintenance and other operations that require special skills are excluded from the general operations. The operator is therefore not permitted to disassemble the main equipment. The operator should read the manual thoroughly and carry out their work with complete understanding of the operating procedures.
Maintenance operator	In addition to the work of the operator described above, the maintenance operator is permitted to perform installation, simple troubleshooting, and periodic inspections. The maintenance operator is required to develop sufficient knowledge and operating skill for this product. The maintenance operator should read the manual thoroughly and carry out their work with complete understanding of the equipment's characteristics and all work contents.
Management supervisor	The management supervisor is required to have sufficient knowledge of the product and advanced operating skill for this product. The management supervisor should manage not only the product itself but on-site operations that handle the product, comprehensively.
Service engineer	In The service engineer is a worker with special knowledge and skills for installing the product, investigating the causes of a failure or damage, and performing repairs and overhauls. Service engineering (the work by the service engineer) is performed by our service technicians or authorized service technicians.

Emergency contact in case of malfunctions







If any problem with the product arises, contact us or your dealer.

CONTENTS

Introduction	1
Notation in this manual	1
Scope of warranty and liabilities for the equipment	2
Definition of intended users for this manual	3
Emergency contact in case of malfunctions	3
1. Precautions for handling	5
2. Maintenance	6
2-1 Daily inspections	6
2-2 Periodical inspections	6
2-3 Replacement of the wire rope	8
2-4 Replacement of the spring	9
2-5 Spring disposal.....	11

1. Precautions for handling

Incorrect handling of this product may cause damage to the product itself as well as a fire or injury. Thoroughly read the following precautions and be sure to heed the instructions when handling the machinery.

 WARNING	
	<ul style="list-style-type: none">• Do not use in explosive, flammable gas, or dusty atmospheres, any place where water or oil may splash, or near combustibles. This may cause fire and injury.• Do not perform any modifications to the product.
	<p>The maintenance should be performed by a maintenance operator who has developed sufficient knowledge and operating skill for the balancer.</p>
	<ul style="list-style-type: none">• Incorrect usage of the product may cause injury. Use the product correctly in accordance with the descriptions in this manual.• Particularly, “WARNING”, “CAUTION”, and “NOTICE” described in this manual must be fully understood and always observed.• Install the product correctly in accordance with the descriptions in this manual.
 CAUTION	
	<ul style="list-style-type: none">• Be sure to perform daily and periodic inspections.• Be sure to use the product within the capacity range that is described in “4-3-1 Specifications” of the Users Manual.

2. Maintenance

⚠ WARNING



The maintenance should be performed by a maintenance operator who has developed sufficient knowledge and operating skill for the balancer.

⚠ CAUTION



Replace any parts using genuine parts only.

Daily and periodic inspections are required for the product to be used safely and properly. If any failure is found in the inspections, the relevant parts must be replaced. For details, contact us or your dealer.

2-1 Daily inspections

Before starting the operation, refer to “6-1 Pre-operation inspections and checks” of the separate Users Manual and perform the inspections and checks daily.

2-2 Periodical inspections

Perform an inspection at least once per month. If the product is used in an unfavorable environment or used frequently, reduce the interval between the inspections.

2-2-1 Inspection of the hook

See the figure below and measure the dimensions of the hook. The hook must be replaced when any dimensions have reached the limiting dimensions. Stop using the balancer, and contact us or your dealer.

■ Operating limit of the top hook

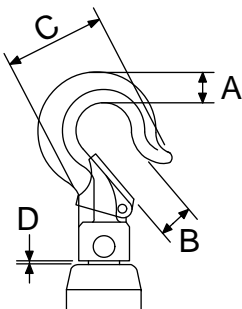

Model	Limiting dimension (mm)			
	A	B	C	D
ELF-3	11.7	15.5	44.0	1.5
ELF-5				
ELF-9				

Operating limit of the bottom hook

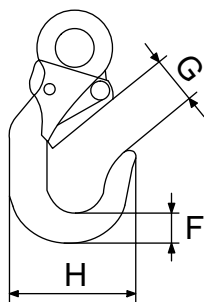

Model	Limiting dimension (mm)		
	F	G	H
ELF-3	8.0	16.5	41.0
ELF-5			
ELF-9			

2-2-2 Inspection of the wire rope

See the figure below and measure the dimension of the wire rope. The wire rope must be replaced when the dimension has reached the limiting dimension or the limiting number of broken wires within one pitch. Stop using the balancer and change the wire rope (see "2-3 Replacement of the wire rope"), or contact us or your dealer.

Operating limit of the wire rope



Model	Dimension J (mm)		Limiting number of broken wires within one pitch
	Reference dimension	Limiting dimension	
ELF-3	3.0	2.7	11
ELF-5			
ELF-9			

Check of the state of the wire rope

Check that there is no deformation or kink in the wire rope.



Deformation

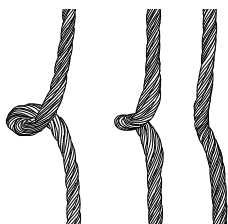

Kink

Note: Kink is the state in which the wire rope is partially deformed due to torsion or looseness.

2-3 Replacement of the wire rope

⚠ WARNING



Do not release the drum lock when the balancer is not loaded or after the tool (equipment) is replaced with one with a different mass (weight). If the drum lock is released in such situations, the wire rope may be quickly wound up as soon as the lock is released, the tool may fall, or an injury may be caused. Attach the tool and adjust the spring tension before releasing the drum lock.

- 1 Lower the tool / device, extending Wire rope (21) to the maximum cable travel.
- 2 Position Plug (31) at the casing opening as shown in Fig.1, and engage the drum lock.
See Users Manual "6-3 Operation method of the drum lock"
- 3 Move the tool / device upward and downward to check Drum (16) is locked securely.
Remove the tool / device from bottom Hook (30) .
- 4 Remove the balancer from the fitting and place on the floor.
- 5 Remove Screw (39), and Bushing(38), Then remove old Wire rope from Drum.
See Users Manual "6-3 Operation method of the drum lock"
- 6 Insert new Wire rope from the A-side, attach Bushing(38) to the Wire rope, and then pass it through Drum and fasten with Screw(39) .
- 7 Install the balancer on the fitting.
See Users Manual "5-2 Installation procedures"
- 8 Attach the tool / device to bottom Hook (30), and release the drum lock.

Fig. 1

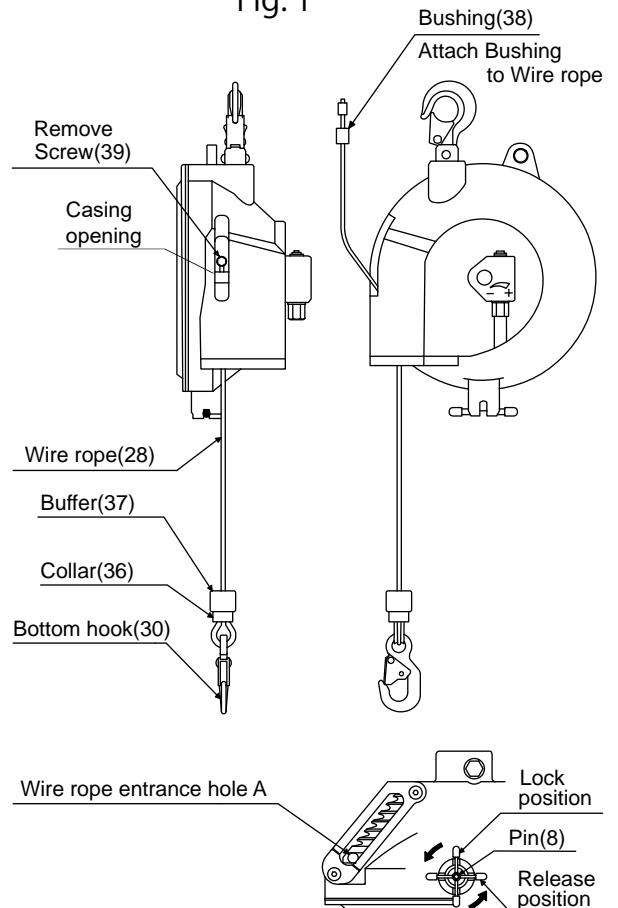

⚠ WARNING



Never release the drum lock before attaching the tool / device. If released, Wire rope (21) will snap back and could cause personal injury.

■ disassembly drawing

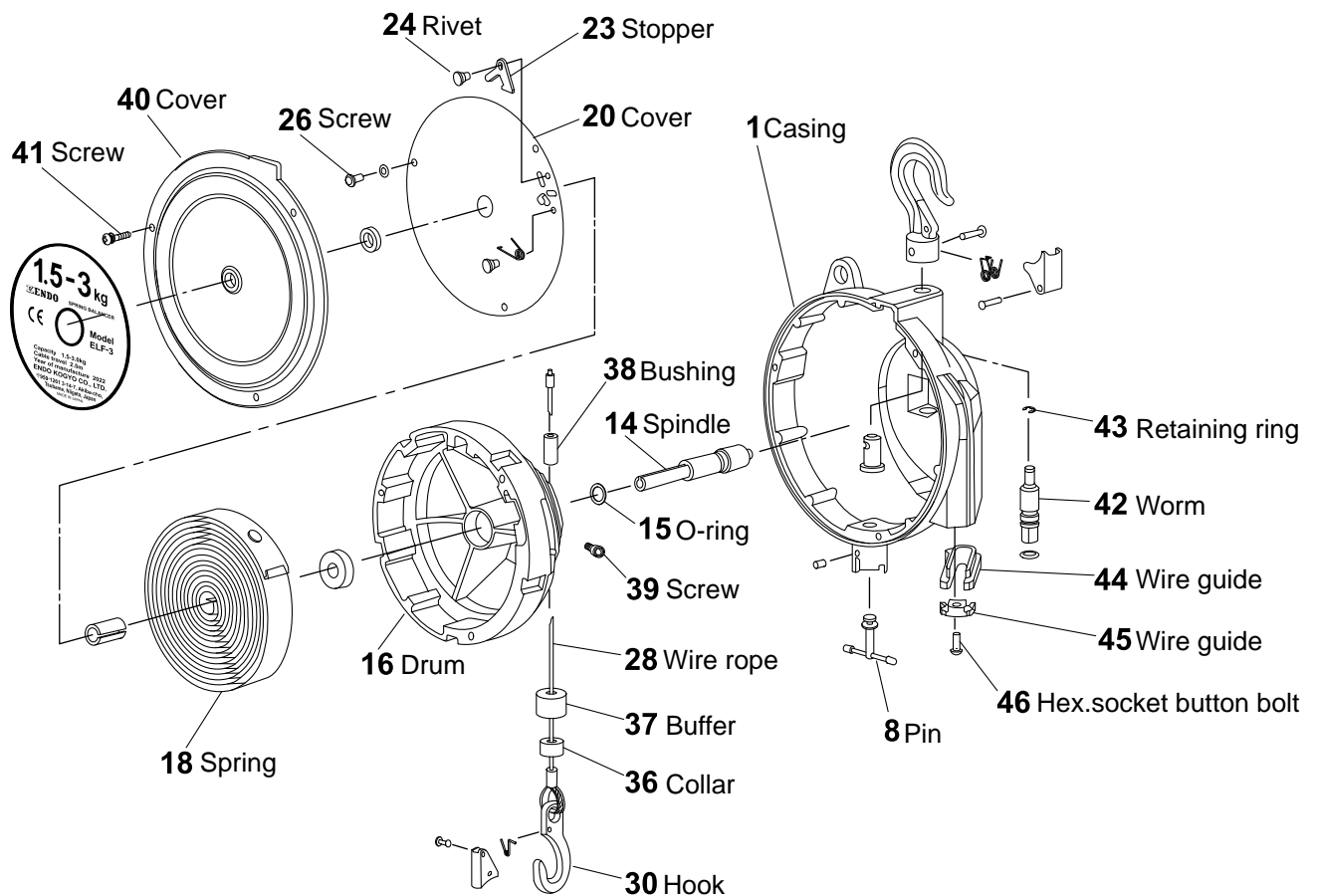

2-4 Replacement of the spring

Never remove the spring from drum unless the replacement is required.
Replace O-ring and the spring at the same time.

⚠ WARNING



- The spring is extremely dangerous. Be careful when handling the spring.
- Never pull the center of the spring when removing the spring from the drum. if pulled, the spring will expand explosively and cause personal injury.

Referring to the disassembly drawing (on pages 10), replace the spring using the following procedure.

- 1 A. When the spring has broken;
Remove the tool / device from bottom Hook (30).
B. When the spring has not broken;
Lift then remove the tool / device from bottom hook (30) when Wire rope (28) is fully retracted into Drum (16).
- 2 Remove the balancer from the fitting and place on the floor.
- 3 Remove Retaining ring (43) from Worm (42). Release all spring tension by turning Worm (42) to the “-” side (counterclockwise) until Worm can almost be removed.

NOTE: Check the spring tension by pulling Wire rope.

- 4 Turn Worm (42) further and remove it.
- 5 Remove Screw (39), Bushing (38) and the Wire rope (28) from Drum(16).
- 6 Loosen Screws (41) and remove Cover (40).
- 7 Remove Drum (16) and Spindle (14) together from Casing (1). Then remove Spindle (14) from Drum (16).
- 8 Loosen Screws (26) and remove Cover (20) from Drum (16).

- 9 Check where is the broken portison of spring (18). Check that the rivet of Spring is not broken. If Spring is broken near the outer periphery where is no space between each turn or the rivet of Spring (18) is broken (see Fig.2), stop the replacement work. Reassemble Cover(20) and contact the dealer. Check Stopper(23) and Rivet(24) when spring breakage. Replace them if they are broken.

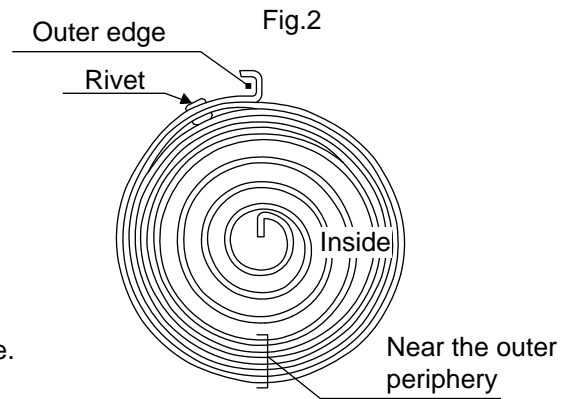

⚠ WARNING

Never remove Spring (14) from Drum (13) when Spring (14) is broken near the outer periphery or the rivet of Spring is broken (see Fig.2). If removed, Spring (14) will expand explosively and cause personal injury.

- 10 Remove Spindle (14) from Drum (16) and remove Spring(18).
- 11 Remove O-ring(15) from Spindle(14).
- 12 Reassemble in reverse order.
 - First install Spindle (14) in Casing (1), then lubricate O-ring(15) with grease. And lubricate Spring with grease.
 - When installing Cover (20) on Drum (16), place Stopper (23) in outer edge of Spring(18), (See fig. 3) Cheek Stopper can move smoothly after installing.

- 13 Wind Spring (18) by turning Worm (42) to the “ + ” side (clockwise).

NOTE: While turning Worm, Wire rope (28) will be retracted into Drum (16). Pay attention Wire rope does not slip out from the drum groove.

After Wire rope is fully retracted, turn Worm by the number of turns shown in Table1.

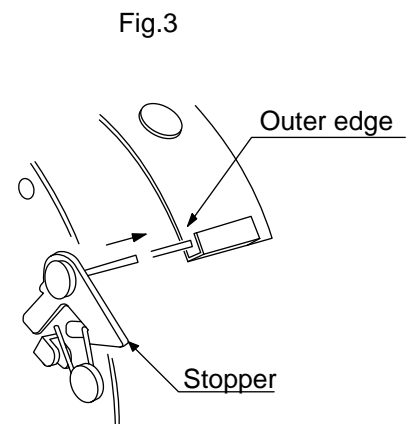

Table-1

Model	ELF-3	ELF5	ELF-9
Number of turns	Approx. 90	Approx. 90	Approx. 85
Numbers above are for the middle value of the capacity range.	2.3kg	2.3kg	2.3kg

2-5 Spring disposal

 **WARNING**



The spring is dangerous due to remaining tension even if it is broken.

Give a warning to disposal companies that the spring will expand explosively and cause danger if the spring is treated roughly or the center of the spring is pulled.

ENDO 遠藤工業株式会社

〒959-1261 新潟県燕市秋葉町3丁目14番7号

<http://www.endo-kogyo.co.jp>

本社営業部 〒959-1261 新潟県燕市秋葉町3丁目14番7号

TEL : 0256-62-5133

FAX : 0256-62-5772

エコファクトリー 〒959-1276 新潟県燕市小池5181番地1

TEL : 0256-63-9306

FAX : 0256-63-4393

東京営業部 〒101-0042 東京都千代田区神田東松下町12番2号JBSL神田ビル2F

TEL : 0256-63-9306

FAX : 0256-63-4393

名古屋営業所 〒460-0011 愛知県名古屋市中区大須1丁目7番14号パークIMビル3F

TEL : 052-253-6231

FAX : 052-253-6240

大阪営業部 〒556-0021 大阪府大阪市浪速区幸町2丁目3番14号ダイトービル3F

TEL : 052-253-6231

FAX : 052-253-6240

九州営業所 〒812-0013 福岡県福岡市博多区博多駅東3丁目11番15号文喜ビル3F

TEL : 052-253-6231

FAX : 052-253-6240

サービス営業グループ 〒959-1261 新潟県燕市秋葉町3丁目14番7号

TEL : 0256-64-4786

FAX : 0256-62-5772

E-mail : service@endo-kogyo.co.jp

ENDO KOGYO CO., LTD

3-14-7, Akiba cho, Tsubame, Niigata 959-1261, Japan

<http://www.endo-kogyo.co.jp> TEL : 81-256-62-5133

- 本書ならびに本製品の仕様は改善のために予告なしに変更することがあります。
- 本書の内容の無断転載を禁止します。
- This manual and the specifications of this product are subject to change for improvement without advance notice.
- It is strictly prohibited to reprint or copy any information contained in this manual.